



Catálogo General

## > Cierres mecánicos Tsurumi

Sellos mecánicos dobles específicos para las bombas de aguas residuales Tsurumi LH, KRS, KTZ, SQ, TRN2 entre otras. Disponibles con las caras de roce en carburo de silicio y elastómero en NBR.



REFER.	Diámetro Eje
TS-H2530	25 - 30
TS-H3035	30 - 35
TS-H4550	45 - 50

REFER.	Diámetro Eje
TS-W-14-HT	14
TS-H20T	20
TS-H25	25
TS-H30T	30
TS-H35	35
TS-HT40	40
TS-H45	45



## > Cierres mecánicos Wilo

Sellos mecánicos para bombas Wilo. Estas bombas se utilizan en todo el mundo para calefacción, climatización, abastecimiento de agua y tratamiento de aguas residuales. Disponible dos modelos de sello mecánico en diferentes diámetros de eje.



REFER.
W-MS-30

REFER.
107



## > Condensadores permanentes 450 V.

Faston	Medidas	Mangue.	Medidas	Mini	Medidas
1-450	25 x 52			1,2-MINI	25 x 52
1,5-450	25 x 52				
2-450	25 x 52				
2,5-450	25 x 52			2,4-MINI	25 x 52
3-450	25 x 52				
4-450	30 x 54	4-MA	30 x 54	4,5-MINI	25 x 52
5-450	30 x 54	5-MA	30 x 54		
6-450	30 x 54	6-MA	30 x 54	6-MINI	30 x 54
8-450	30 x 70	8-MA	30 x 70	8-MINI	30 x 54
9-450	35 x 56	9-MA	35 x 56		
10-450	30 x 70	10-MA	30 x 70	10-MINI	35 x 54
12-450	35 x 70	12-MA	35 x 70	12-MINI	35 x 54
12,5-450	35 x 70	12,5-MA	35 x 70		
14-450	35 x 70	14-MA	35 x 70	14-MINI	35 x 70
15-450	35 x 70	15-MA	35 x 70		
16-450	35 x 70	16-MA	35 x 70	16-MINI	35 x 70
18-450	40 x 70	18-MA	40 x 70	18-MINI	40 x 70
20-450	40 x 70	20-MA	40 x 70	20-MINI	40 x 70
22-450	40 x 70	22-MA	40 x 70		
24-450	40 x 70	24-MA	40 x 70		
25-450	40 x 94	25-MA	40 x 94	25-MINI	45 x 70
30-450	40 x 94	30-MA	40 x 94	30-MINI	45 x 70
31,5-450	45 x 70				
35-450	45 x 94	35-MA	45 x 94	35-MINI	45 x 94
40-450	45 x 94	40-MA	45 x 94	40-MINI	45 x 94
45-450	45 x 94	45-MA	45 x 94		
50-450	50 x 94	50-MA	50 x 94		
55-450	50 x 94	55-MA	50 x 94		
60-450	50 x 120	60-MA	50 x 120		
65-450	50 x 120	65-MA	50 x 120		
70-450	50 x 120	70-MA	50 x 120		
80-450	55 x 120	80-MA	60 x 119		
90-450	65 x 120				
100-450	65 x 120				
120-450	65 x 120				







## Condensadores arranque



TIPO	220 v.
63-76 MF	46 x 85
80-96 MF	46 x 85
100-120 MF	46 x 85
125-150 MF	46 x 85
156-187 MF	46 x 85
200-240 MF	46 x 85
250-300 MF	46 x 85
315-378 MF	46 x 111
400-480 MF	46 x 111
500-600 MF	46 x 111
600-700 MF	50 x 111



## Condensadores Xenon

Cable-T	mf	Medidas
X-50	50 mf	55 x 120
X-70	70 mf	55 x 120
X-80	80 mf	55 x 120
X-120	120 mf	60 x 150

Los condensadores Xenon, van provistos de una lámina metálica interior, que hace las veces de un disyuntor centrifugo, necesario para un arranque en los motores que se montan en los compresores y otros con alto poder de arranque, por lo cual se utiliza el condensador de arranque y el Xenon permanente, que actúa una vez arrancado el motor, desconectándose la parte metálica del Xenon.





## > Caperuzas goma condensadores



## > Comprobador de condensadores

**REFER.**

PM-51

Selección de funciones  
Funciones V CC y V CA  
Funciones de resistencia, continuidad, diodos y capacitancia  
Función de frecuencia





## Terminales aislados



REFER.	REFER.	Tornillo	Sección
<b>Redondo</b>	<b>Horquilla</b>		
15032	15032A	3.2	0.25-1.65
15037	15037A	3.7	0.25-1.65
15043	15043A	4.3	0.25-1.65
15053	15053A	5.3	0.25-1.65
15064	15064A	6.4	0.25-1.65
15084	15084A	8.4	0.25-1.65
15105	15105A	10.5	0.25-1.65
25032	25032A	3.2	1.04-2.63
25037	25037A	3.7	1.04-2.63
25043	25043A	4.3	1.04-2.63
25053	25053A	5.3	1.04-2.63
25064	25064A	6.4	1.04-2.63
25084	25084A	8.4	1.04-2.63
25105	25105A	10.5	1.04-2.63
55037	55037A	3.7	2.63-6.64
55043	55043A	4.3	2.63-6.64
55053	55053A	5.3	2.63-6.64
55064	55064A	6.4	2.63-6.64
55084	55084A	8.4	2.63-6.64
55105	55105A	10.5	2.63-6.64

## > Terminales aislados Faston hembra



REFER.	Modelo	Sección
15028	2.8	0,25-1,65
15048	4.8	0,25-1,65
15063	6.3	0,25-1,65
25048	4.8	1,04-2,63
25063	6.3	1,04-2,63
55063	6.3	2,63-6,64

## > Terminales aislados Faston hembra

REFER.	Tipo	Sección
15048-2	4.8	0,25-1,65
15063-2	6.3	0,25-1,65
25048-2	4.8	1,04-2,63
25063-2	6.3	1,04-2,63
55063-2	6.3	2,63-6,64



## > Terminales aislados Faston macho



REFER.	Tipo	Sección
15480	4.8	0,25-1,65
15635	6.3	0,25-1,65
25480	4.8	1,04-2,63
25635	6.3	1,04-2,63
55635	6.3	2,63-6,64



## > Terminales aislados Faston mixtos

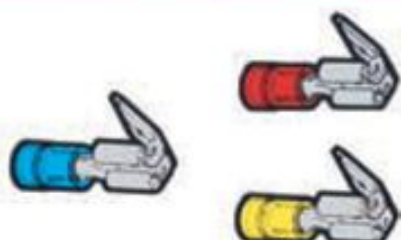

REFER.	Modelo	Sección
15635-1	6.3	0,25-1,65
25635-1	6.3	1,04-2,63
55635-1	6.3	2,63-6,64

## > Terminales aislados cilíndricos

REFER.	Modelo	Sección
15039	Hembra	0,25-1,65
25039	Hembra	1,04-2,63
15040	Macho	0,25-1,65
25040	Macho	1,04-2,63



## > Conectores aislados

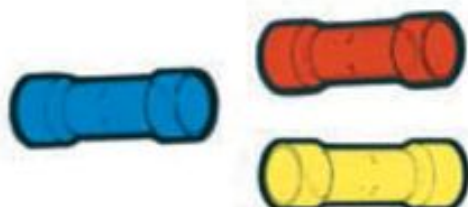

REFER.	Sección
15017	0,25-1,65
25023	1,04-2,63
55034	2,63-6,64

## > Terminales punta aislados

REFER.	Sección
15019	0,25-1,65
25019	1,04-2,63
55027	2,63-6,64

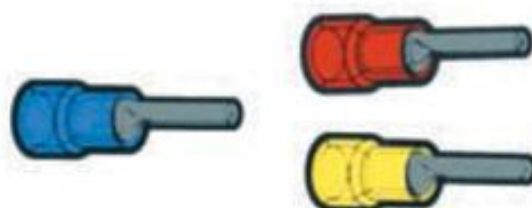

## > Empalmes aislados ciegos nylon



REFER.	Sección
NCE-1	0,5-1,65
NCE-2	1,0-3,0
NCE-5	2,5-6,0
NCE-8	4,0-9,0

> **Conector-empalme soldadura con aislante termo-contable "estanco"**



REFER.	Sección	Medidas	Color
SBS-0,5	0,50-1,00	2,50x3,50x25	Amarillo
SBS-1	0,50-1,50	4,23x5,50x37	Rojo
SBS-2	1,50-2,50	4,70x6,40x37	Azul
SBS-5	4,00-6,00	7,10x8,00x42	Amarillo

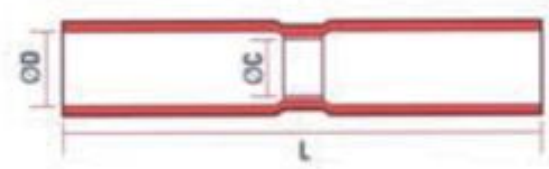

Con adhesivo interno

> **Punteras aisladas**

REFER.	Sección	Color
TE-0,25	0,25	Amarillo
TE-0,50	0,5	Blanco
TE-0,75	0,75	Azul
TE-1,00	1	Rojo
TE-1,50	1,5	Negro
TE-2,50	2,5	Gris
TE-4,00	4	Naranja
TE-6,00	6	Verde
TE-10,00	10	Marrón
TE-16,00	16	Marfil
TE-25,00	25	Negro
TE-35,00	35	Rojo
TE-50,00	50	Azul



## > Punteras aisladas DUO



REFER.	Sección	Color
DU0-050	0.5	Blanco
DU0-0.75	0.75	Gris
DU0-1.00	1	Rojo
DU0-1.50	1.5	Negro
DU0-2.50	2.5	Azul
DU0-4.00	4	Gris
DU0-6.00	6	Amarillo
DU0-10.00	10	Rojo
DU0-16.00	16	Azul

## > Terminales para tornillo

REFER.	Tornillo	Sección
13626	4.2	0.5-1.0
13370	3.2	0.75-2.0
13372	4.2	0.75-2.0
13374	5.2	0.75-2.0
13378	6.2	0.75-2.0
13310	8.5	1.0-2.5
13312	9.5	1.0-2.5
13314	10.5	1.5-4.0
13840	4.2	0.5-1.0





## > Terminales desnudos



Faston Hembra



Faston Hembra  
con retén



Faston Macho



Faston Macho  
con retén

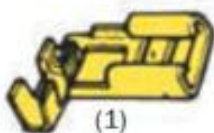

(1)



(2)



(3)

REFER.	Tipo	Sección
14408	2,8 x 0,5	0,5-1,0
14410	2,8 x 0,8	0,5-1,0
14418	4,8 x 0,8	1,0-2,5
14468	5,0 x 0,8	1,0-2,5
14648	6,3 x 0,8	1,0-2,5
14478	9,5 x 1,2	2,5-6,0
14310	2,8 x 0,8	0,5-1,0
14323	6,3 x 0,8	0,5-1,0
14327	6,3 x 0,8	1,0-2,5
15060	2,8 x 0,5	0,75-1,5
16413	4,8 x 0,5	0,5-2,0
16422	6,3 x 0,8	1,0-2,5
16408	2,8 x 0,8	1,0-2,5
16466	5,0 x 0,8	1,0-2,5
16432	6,3 x 0,8	1,0-2,5
(1) 15422	6,3 x 0,8	1,0-2,5
(2) 15222	6,3 x 0,8	0,75-1,5
(3) 3838	6,3 x 0,8	

## > Terminales tubulares cobre

REFER.	Sección	Tornillo
TD-1,5-4	1.5	4.2
TD-1,5-5	1.5	5.2
TD-2,5-4	2.5	4.2
TD-2,5-5	2.5	5.2
TD-2,5-6	2.5	6.5
TD-4-4	4	4.2
TD-4-5	4	5.2
TD-4-6	4	6.5
TD-6-5	6	5.2
TD-6-6	6	6.5
TD-6-8	6	8.4
TD-6-10	6	10.5
TD-10-6	10	6.5
TD-10-8	10	8.4
TD-10-10	10	10.5
TD-10-12	10	13.2
TD-16-6	16	6.5
TD-16-8	16	8.4
TD-16-10	16	10.5
TD-16-12	16	13.2
TD-25-6	25	6.5
TD-25-8	25	8.4
TD-25-10	25	10.5
TD-25-12	25	13.2

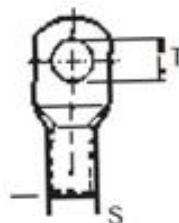

REFER.	Sección	Tornillo
TD-35-8	35	8.4
TD-35-10	35	10.5
TD-35-12	35	13.2
TD-50-10	50	10.5
TD-50-12	50	13.2
TD-50-14	50	15
TD-70-10	70	10.5
TD-70-12	70	13.2
TD-70-14	70	15
TD-70-16	70	17
TD-95-8	95	8.4
TD-95-10	95	10.5
TD-95-12	95	13.2
TD-95-14	95	15
TD-95-16	95	16
TD120-10	120	10.5
TD120-12	120	13.2
TD120-14	120	15
TD120-16	120	16
TD150-10	150	10.5
TD150-12	150	13.2
TD150-14	150	15
TD150-16	150	16

## > Terminal estañado

REFER.	Sección	Tornillo
D-3.7-1	0,5-1,5	3.7
D-3.7-2,5	1,5-2,5	3.7
D-4.3-1	0,5-1,5	4.3
D-4.3-2,5	1,5-2,5	4.3
D-4-6	2,5-6	4.3
D-5.3-1	0,5-1,5	5.3
D-5.3-2,5	1,5-2,5	5.3
D-5-6	2,5-6	5.3
D-6-6	2,5-6	6.5
D-6-10	10	6.5
D-6.5-2,5	1,5-2,5	6.5
D-8.4-2,5	1,5-2,5	8.4
D-8-6	2,5-6	8.4
D-8-10	10	8.4
D-8-16	16	8.4
D-8-25	25	8.4
D-8-35	35	8.4

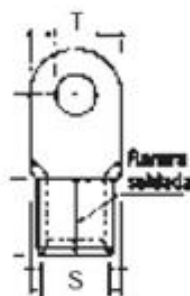

REFER.	Sección	Tornillo
D-10-6	2,5-6	10.5
D-10-10	10	10.5
D-10-16	16	10.5
D-10-25	25	10.5
D-10-35	35	10.5
D-10-50	50	10.5
D-10-70	70	10.5
D-12-10	10	13
D-12-16	16	13
D-12-25	25	13
D-12-35	35	13
D-12-50	50	13
D-12-70	70	13
D-16-25	25	17
D-16-35	35	17
D-16-50	50	17
D-16-70	70	17

## > Conectores cobre

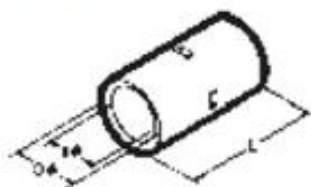

REFER.	Sección	D	d	L
TC-1.5	1.5	3.7	2.1	20
TC-2.5	2.5	4.0	2.4	25
TC-4	4	4.8	3.1	25
TC-6	6	5.5	3.8	25
TC-10	10	6.2	4.5	30
TC-16	16	7.1	5.4	35
TC-25	25	8.8	6.8	40
TC-35	35	10.6	8.2	45
TC-50	50	12.4	9.5	50
TC-70	70	14.7	11.2	55
TC-95	95	17.4	13.5	60
TC-120	120	19.4	15.0	65
TC-150	150	21.2	16.5	70



## > Brida - Atado bobinas

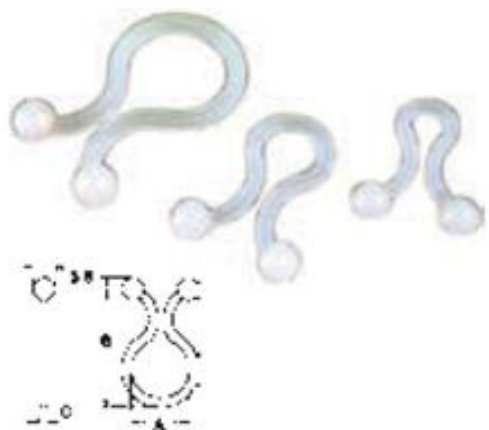

REFER.	Largo	Ancho Int.
TT-05	20.6	5.1
TT-08	25.4	8
TT-11	29.3	11.3
TT-15	34	15
TT-18	40	18.6
TT-24	45.5	24

## > Fundas terminales

REFER.	Terminal	Medidas
PH-1001	Hembra 2,8	18 x 5,5
PH-1011	Hembra 4,8	20 x 7,6
PH-1021	Hembra 6,3	24 x 9



## > Cinta adhesiva aislante



### AUTOEXTINGUIBLE

REFER.	Mtrs.	Ancho	Exesor
CN10	10	19	0.15
CN20	20	19	0.15
CN25	25	19	0.15

Colores: Negro, rojo, amarillo, azul, blanco, gris, marrón, verde, tierra

## > Cinta empalme vulcanizada

REFER.	Mtrs.	Ancho	Exesor
1019-V	10	19	0.75

Hasta 69 KV. Color negro

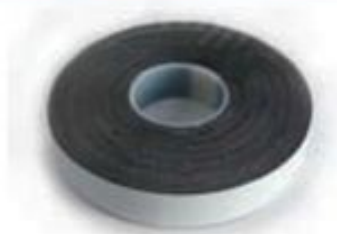

## > Bridas sujeta-cables

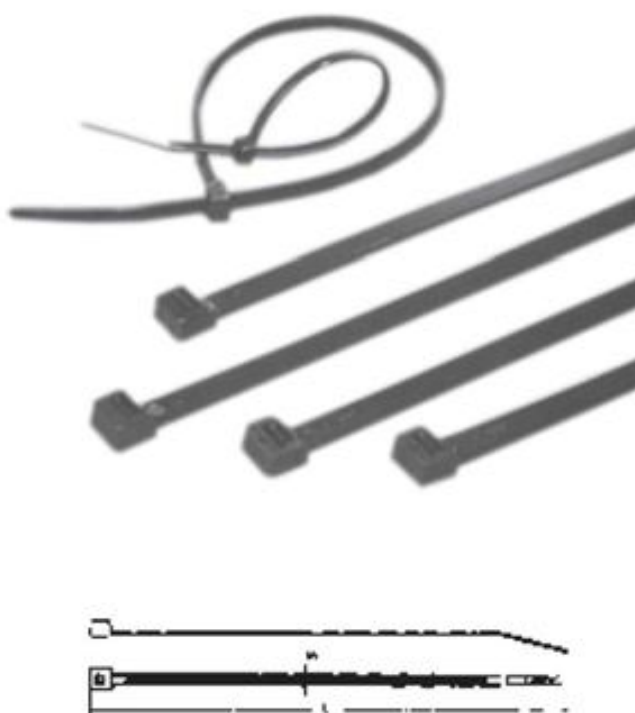

REFER.	Largo	Ancho
CV-075B	75	2.4
CV-100B	100	2.5
CV-120SB	120	2.5
CV-120B	120	3.2
CV-140SB	142	2.5
CV-140B	142	3.2
CV-150B	150	3.7
CV-165B	165	2.5
CV-180B	180	4
CV-190B	190	4.8
CV-200MB	203	2.5
CV-200SB	203	3.2
CV-200B	203	4.6
CV-200LB	203	7.6
CV-240LB	240	7.6
CV-250MB	250	3.6
CV-250B	250	5
CV-280B	280	5
CV-292B	292	3.6
CV-300B	300	7.9
CV-310B	310	5
CV-368B	368	5
CV-380B	380	7.9
CV-450B	450	8
CV-550B	550	8

## > Regletas de conexión poliamida

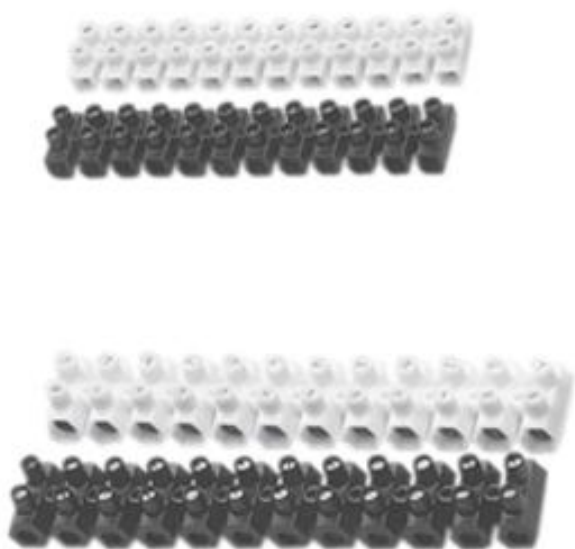

REFER.	Sección	Nº.Polos
1102	2.5	12
1122	4-6	12
1142	10	12
1152	16	12
RCE-04	4	12
RCE-06	6	12
RCE-10	10	12
RCE-16	16	12
RCE-25	25	12

## > Conectores multivías

REFER.	REFER.	Vías	Terminal
<b>P. Macho</b>	<b>P. Hembra</b>		
12-2100	12-3100	1	6.3
12-2101	12-3101	2	6.3
12-2102	12-3102	3	6.3
12-2103	12-3103	4	6.3
12-2104	12-3104	6	6.3
12-2108	12-3108	8	6.3





## > Tubo termo-retráctil

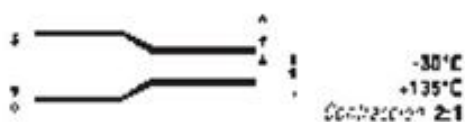

Suministro barras de metro o rollos

REFER.	Int. Ant.	Int. Desp.	Grueso D.
PT-1,2	1.2	0.6	0.45
PT-1,6	1.6	0.8	0.45
PT-2,4	2.4	1.2	0.5
PT-3,2	3.2	1.6	0.5
PT-4,8	4.8	2.4	0.5
PT-6,4	6.4	3.2	0.65
PT-9,5	9.5	4.8	0.65
PT-12,7	12.7	6.4	0.65
PT-19,0	19	9.5	0.75
PT-25,4	25.4	12.7	0.9
PT-38,0	38	19	1
PT-51,0	51	25.4	1.15
PT-76,0	76	38	1.25

## > Tubo termo-retráctil

### Estuches

REFER.	Metros	Int. Ant.	Int. Desp.	Grueso D.
PTE-1.2	15 mts.	1.2	0.6	0.5
PTE-1.6	15 mts.	1.6	0.8	0.5
PTE-2.4	15 mts.	2.4	1.2	0.5
PTE-3.2	15 mts.	3.2	1.6	0.5
PTE-4.8	12 mts.	4.8	2.4	0.5
PTE-6.4	12 mts.	6.4	3.2	0.65
PTE-9.5	8 mts.	9.5	4.8	0.65
PTE-12.7	8 mts.	12.7	6.4	0.65
PTE-19.0	5 mts.	19	9.5	0.75
PTE-25.4	5 mts.	25.4	12.7	0.9



Contracción: 2:1

## > Tubo termo-retráctil adhesivo interior

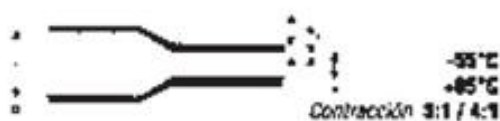

Suministro barras de metro

REFER.	Int. Ant.	Int. Desp.	Grueso D.
PLDW-3.0	3	1	1,1-0,5
PLDW-6.0	6	2	1,1-0,5
PLDW-9.0	9	3	1,3-0,6
PLDW-12.0	12	4	1,5-0,7
PLDW-19.0	19	6	2,0-0,8
PLDW-25.0	25	8	2,5-1,0
PLDW-39.0	39	13	2,5-1,0

## > Tubo termo-retráctil pared media adhesivo interior

REFER.	Int. Ant.	Int. Desp.	Grueso D.
SRH2-8-2	8	2	1.3
SRH2-12-3	12	3	1.4
SRH2-22-6	22	6	2
SRH2-34-7	34	7	2.6
SRH2-40-12	40	12	2.6



Contracción: 4:1

Suministro barras de metro. Otras medidas consultar

## > Estuches vacíos



REFER.	Material	Huecos	Medidas
CS-25	Plástico	32	335x250x55
E-13	Plástico	32	320x225x50
CB6623	Metálico	48	440x330x66



## > Estuches anillos



### Caja de juntas, juntas tóricas, hilo tórico

Materiales: NBR, FPM, VQM, EPDM, ETC...  
Cajas de juntas tóricas en métrica y pulgadas  
Hilo tórico para poder fabricar cualquier diámetro en aplicaciones estáticas

**REFERENCIA: DIN-471**  
**INTERIORES**  
De 8 a 32

**REFERENCIA: DIN-472**  
**EXTERIORES**  
De 4 a 30



### REFERENCIA: OK-311 M



(medidas en métrica)  
COMPOSICIÓN: 30 medidas - 404 piezas

Cant.	Medida	Cant.	Medida	Cant.	Medida
18 U	3x2	14 U	14x2,5	12 U	28x3
18 U	4x2	14 U	16x2,5	12 U	30x3
18 U	5x2	14 U	17x2,5	12 U	32x3
18 U	6x2	14 U	19x2,5	12 U	33x3
17 U	7x2	14 U	19x3	12 U	35x3
17 U	8x2	12 U	20x3	12 U	36x3
17 U	10x2	12 U	22x3	12 U	38x3
17 U	10x2,5	12 U	24x3	9 U	38x4
17 U	11x2,5	12 U	25x3	9 U	42x4
17 U	12x2,5	12 U	27x3	9 U	45x4

Cant.	Medida	Cant.	Medida	Cant.	Medida
20 U	2,90x1,78	13 U	13,92x2,62	10 U	28,17x3,53
20 U	3,68x1,78	13 U	15,54x2,62	10 U	29,75x3,53
20 U	4,48x1,78	13 U	17,12x2,62	10 U	31,34x3,53
20 U	5,28x1,78	13 U	9,19x2,62	10 U	32,92x3,53
20 U	6,07x1,78	10 U	18,64x3,53	10 U	34,52x3,53
20 U	7,65x1,78	10 U	20,22x3,53	10 U	36,10x3,53
20 U	9,25x1,78	10 U	20,22x3,53	10 U	37,69x3,53
20 U	3,68x1,78	10 U	23,40x3,53	7 U	37,47x5,33
13 U	10,77x2,62	10 U	24,99x3,53	7 U	40,65x5,33
13 U	12,31x2,62	10 U	26,58x3,53	7 U	43,82x5,33

### REFERENCIA: OK-311 P



(medidas en pulgadas)  
COMPOSICIÓN: 30 medidas - 382 piezas

## > Herramientas terminales



**DL-10**

Engaste de punteras de secciones desde 0,75 hasta 10.



**DL-16**

Engaste de punteras de secciones desde 4 hasta 16.



**HL-500**

Soplador de calor hasta 525 ° C



**KH-14**

Engaste de terminales tubulares hasta secciones de 16.



**LK-38A**

Cortadora de cables manual hasta sección 38.



**LK-60A**

Cortadora de cables manual hasta sección 60.



## > Herramientas terminales



**LK-325A**

Cortadora de cables manual hasta sección 240.



**LK-520A**

Cortadora de cables manual hasta sección 400.



**LY-03B**

Engaste de terminales con garras, desde 0,5 hasta 6 mm. de sección



**LY-03C**

Engasta conductor y aislante, para terminales aislados, sec. 1,5-2,5 y 6.



**ME-22C**

Cortadora de cables manual hasta sección 22.



**ME-250**

Cortadora de cables manual hasta sección 250.

## > Herramientas terminales



**MEB-300**

Engaste de terminales con garras, secciones 1,5-2,5 y 6.



**MEB-400**

Engaste de termin. aislados y de presión secciones 1,5-2,5 y 6. Corta pelacables.



**MEB-500**

Engaste de terminales aislados y desnudos con garras, secciones 1,5-2,5 y 6. Corta p.



**MEB-600**

Engaste de terminales con garras, secciones 1,5-2,5 y 6.



**MES-202**

Pelacables tradicional.

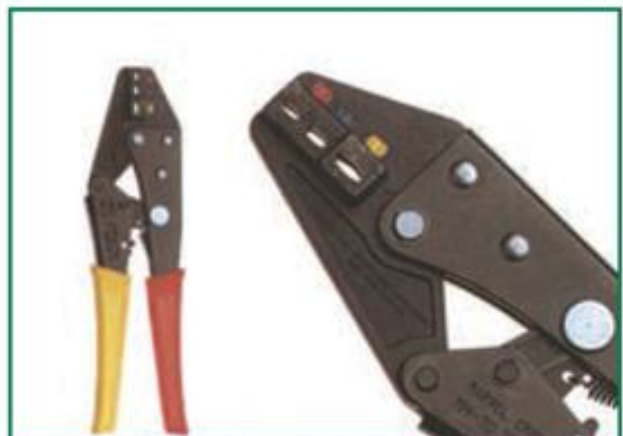

**MH-3D**

Engasta conductor y aislante, para terminales aislados, secciones 1,5-2,5 y 6.



## > Herramientas terminales



**MH-3F**

Engaste de terminales con garras, desde 0,5 hasta 6 mm. de sección



**MH-99**

Engaste de terminales tubulares hasta secciones de 25.



**RYO-150**

Engaste de terminales tubulares hasta secciones de 10 hasta 150.



**XB-051**

Engaste de terminales aislados y desnudos con garras, secciones 1,5-2,5 y 6. Corta p.



**XB-052**

Engaste de terminales con garras, desde 0,5 hasta 6 mm. de sección



**XB-101P**

Pelacables automático.



## > Herramientas terminales



**XB-115**

Pelacables automático.



**XB-1904**

Engaste de punteras de secciones de 0,5 hasta 16.



**XB-7390**

Engaste de punteras sección hasta 6 y DUO hasta 1,5. Entrada frontal



**XB-9083**

Engaste de punteras de secciones de 0,5 hasta 6.



**XB-9084**

Engaste de punteras de secciones de 6 hasta 16.

## > Transformadores especiales hechos a medida

Bajo pedido o demanda, se hacen toda clase de transformadores.





## > Transformador monofásico de control

### Características técnicas

Protección de choques eléctricos Clase II.  
Frecuencia 50/60 Hz.  
Temperatura ambiente 25° C.  
Índice de protección IP20.  
Aislamiento térmico Clase B

Sistema de fijación en carril DIN hasta 630 VA opcional.

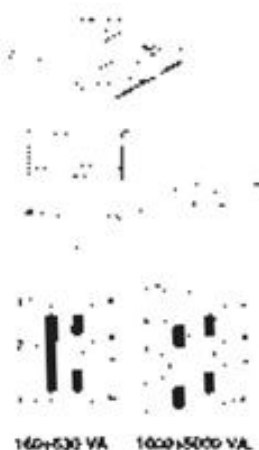

Para uso general seleccionar la potencia nominal acorde a la carga y su factor de potencia:

$$VA = w / \text{Cos}$$

Para uso como transformador de control de elementos como relés, contactores, electroválvulas, etc.:

- 1° Sumar todas las potencias de mantenimiento de los elementos.
- 2 Multiplicar el resultado x 4. Se obtiene la potencia nominal del transformador VA.

Comprobar que la potencia instantánea del transformador seleccionado (consulte tabla inferior) sea mayor que las potencias simultáneas de los elementos de control

**Transformador de control** para mando, maniobra, señalización, enclavamiento, etc.

**Transformador de seguridad** (secundario < 50V) elimina riesgo de accidente en caso de contacto bipolar.

**Transformador de aislamiento** (secundario > 50V) elimina riesgo de accidente en caso de contacto unipolar.

Potencia VA		REFER.			Dimensiones (mm)					
Nominal	Inst.	Sec. 12-24 V	Sec. 24-48 V	Sec. 115-230 V	A	B	C	D	E	Diam.
25	(65)	CSE0025-1	CSE0025-2	CSE0025-3	82	90	91	79	58	5,5x12
40	(80)	CSE0040-1	CSE0040-2	CSE0040-3	82	90	91	79	58	5,5x12
63	(135)	CSE0063-1	CSE0063-2	CSE0063-3	82	90	96	79	58	5,5x12
100	(210)	CSE0100-1	CSE0100-2	CSE0100-3	82	90	106	79	58	5,5x12
160	(370)	CSE0160-1	CSE0160-2	CSE0160-3	94	106	117	90	58	7x14
200	(460)	CSE0200-1	CSE0200-2	CSE0200-3	105	115	116	99	70	7x14
250	(650)	CSE0250-1	CSE0250-2	CSE0250-3	105	115	127	99	70	7x14
315	(875)	CSE0315-1	CSE0315-2	CSE0315-3	115	119	127	106	80	7x14
400	(1250)	CSE0400-1	CSE0400-2	CSE0400-3	115	123	142	106	80	7x14
500	(1400)	CSE0500-1	CSE0500-2	CSE0500-3	135	148	144	132	91	7x16
630	(1800)	CSE0630-1	CSE0630-2	CSE0630-3	135	148	164	132	91	7x16
1000	(3200)	CSE1000-1	CSE1000-2	CSE1000-3	150	158	196	143	124	7x16
1600	(5350)		CSE1600-2	CSE1600-3	150	158	236	143	124	7x16
2000	(5600)		CSE2000-2	CSE2000-3	195	214	201	195	165	7x16
2500	(7800)		CSE2500-2	CSE2500-3	195	214	221	195	165	7x16
3150	(10100)			CSE3150-3	195	214	241	195	165	7x16
4000	(12500)			CSE4000-3	240	250	288	230	200	9x18
5000	(15000)			CSE5000-3	240	250	308	230	200	9x18



## > Autotransformador trifásico

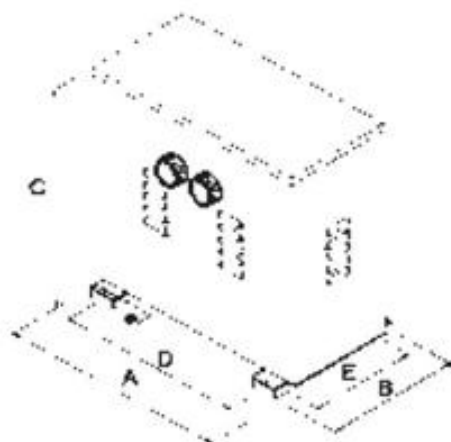

**Dimensiones (mm)**

Potencia kVA	REFER.	A	B	C	D	E	Diam.	Peso kg
3	ATC003	230	180	240	140	160	6	11.2
4	ATC004	300	220	300	200	200	6	14.8
6	ATC006	300	220	300	200	200	6	19.9
8	ATC008	300	220	300	200	200	6	24.7
10	ATC010	370	260	370	200	240	6	28.8
12	ATC012	370	260	370	200	240	6	34.9
16	ATC016	370	260	370	200	240	6	43
20	ATC020	370	260	370	200	240	6	53
25	ATC025	450	320	460	320	290	9	63
31	ATC031	450	320	460	320	290	9	76
40	ATC040	520	360	555	350	330	9	88
50	ATC050	520	360	555	350	330	9	107
63	ATC063	590	400	630	400	370	9	134
80	ATC080	590	400	630	400	370	9	164
100	ATC100	590	400	630	400	370	9	192
125	ATC125	750	540	880	450	490	9	231
160	ATC160	750	540	880	450	490	9	270
200	ATC200	750	540	880	450	490	9	344
250	ATC250	750	540	880	450	490	9	409
315	ATC315	900	640	1170	550	590	13	486
400	ATC400	900	640	1170	550	590	13	568



## Transformador monofásico de piscina



CPE (Fig. 1)



CPE (Fig. 1)



CPEH (Fig. 2)



CPEH (Fig. 2)

### CPE (Fig. 1) Montaje vertical

Potencia	REFER.	Dimensiones (mm)					
		A	B	C	D	E	Diam.
100	CPE100	94	108	102	90	58	7x15
300	CPE300	115	123	134	106	80	7x14
600	CPE600	135	148	172	132	91	7x16

**Transformador de seguridad** (secundario < 50V) elimina riesgo de accidente en caso de contacto bipolar.

**Destinado para alimentación** de focos de piscina, fuentes y jardines.

**Corrección de caídas** de tensión entre transformador y carga.

#### Características técnicas

Protección de choques eléctricos Clase II.

Frecuencia 50/60 Hz.

Temperatura ambiente 25° C.

Índice de protección IP20.

Aislamiento térmico Clase B

- Encapsulado en resina autoextinguible.
- Sistema de fijación a carril DIN opcional.
- Protección térmica frente a sobrecargas y sobretensión.
- Regulación por tomas en primario según distancia entre transformador y el foco. Ver esquema.
- Conexiones con tapa de protección.
- **CPE:** Montaje vertical.
- **CPEH:** Montaje horizontal.

### CPEH (Fig. 2) Montaje horizontal

Potencia	REFER.	Dimensiones (mm)					
		A	B	C	D	E	Diam.
100	CPEH100	94	116	83	100	56	7x15
300	CPEH300	115	146	101	130	82	7x14
600	CPEH600	135	182	117	166	91	7x16

## > Bobinado de inducidos y bobinas

Se bobinan toda clase de Inducidos, Bobinas, Rotores, Corriente Continua, Maquinaria, Máquinas Electroportátiles, etc., así como cualquier clase de frenos, que tengan a bien enviarnos para su reparación.



## > Bobinado de frenos



## > Colectores normales y de anillos

Colector Delgas	
Nd	Nº Delgas
Lt	Largo total
Lc	Largo colector
Dt	Diámetro total
Du	Diámetro útil
V	Ancho
A	Eje
Sa	Saliente anterior
Sp	Saliente posterior



Colector Anillos	
Na	Nº anillos
A	Largo portacolector
B	Distancia entre anillos
C	Ancho de anillos
D	Saliente del portacolector
E	Diámetro útil anillo
F	Diámetro eje
G	Salida conexiones





## Botoneras colgantes



P0-3.1

P0-2.1

P0-3.1P

PL-05

PL-07



PL004001



PL004002



PL005085

REFER.	Funciones
P0-2.1	2 Pulsadores 1 Velocidad 1 NA
P0-3.1	2 Pulsadores + Seta Emergencia 1 Velocidad 1NA - 1NC
P0-3.1P	2 Pulsadores + Seta Emergencia Maniobras: 2 NA + 1 NC Emergencia: 3 NC Para motores 380v. Hasta 3 CV.
PL-05	4 Pulsadores + Seta Emergencia Maniobras 1NA, Emergencia 1NC
PL-07	6 Pulsadores + Seta Emergencia Maniobras 1NA, Emergencia 1NC
PL004001	Contacto Rojo NC
PL004002	Contacto Verde NA
PL005085	Contacto Negro

Diseño moderno, estructura anatómica ligera, práctica y de accionamiento con una sola mano para una máxima libertad de movimiento del usuario.

Características Generales. Caja en material termoplástico autoextinguible con doble aislamiento. Grado de protección IP65 EN60529.

Temperatura de funcionamiento -25°C + 70 °C. Según IEC 68-2-27.

Temperatura de almacenamiento -40°C + 70°C.

Tipos: de 2 a 14 agujeros Diámetro 22 en 1 ó 2 filas. Entrada de cable: P03 pasamuros de Diam. 8 a Diam- 17, PL y PLB pasamuros de Diam. 8 a Diam. 24. Seta de emergencia según EN60204-1 as EN418 permitiendo hasta 3 contactos NC. Vida de pulsadores y selectores: 1 millón de maniobras.

Características de los contactos de maniobra. Material autoextinguible VO UL94. Intensidad nominal térmica 16 A. Tensión nominal de aislamiento 600 V. Resistencia de los contactos igual o menor de 25 m.

## > Portabrocas

### CON LLAVE

El agujero central permite el paso de un tornillo de bloqueo.



REFER.	Capacidad	Acoplamiento	
1220	1,5-13	1/2 "	20 Hembra
3824	1,5-13	3/8 "	24 Hembra

Profesional para máquinas portátiles y taller.

1220E	1,5-13	1/2 "	20 Hembra
1220ES	1,5-13	1/2 "	20 Hembra

### SIN LLAVE

Profesional para taladros reversibles y percusión.

REFER.	Capacidad	Acoplamiento	
1220L	1,5-13	1/2 "	20 Hembra
1220L-10	10	1/2 "	20 Hembra
3824L	1,5-13	3/8 "	24 Hembra
3824L-10	10	3/8 "	24 Hembra



Super dos cuerpos metalicos para taladros reversibles y percusión.

REFER.	Capacidad	Acoplamiento	
1220-RP	1,5-13	1/2 "	20

### SIN LLAVE

Profesional cierre rápido para máquinas portátiles y taller.

REFER.	Capacidad	Acoplamiento	
1220-P	1,5-13	1/2 "	20
VSR 13 D 6	Tornillo		M6
ACSDSV1	Adaptador	1/2"	20



## > Nuevos inducidos adaptables



REFER.	Marca	Ref. Original	Adaptable
RB-1000	Bosch	1604011176C	Radial GWS18-230-GWS20-230
RB-1001	Bosch	1604011932L	Radial GWS23-230-GWS24-230
RB-1002	Bosch	1604011148C	Radial GWS21-180-GWS21-230
RB-1003	Bosch	1604010626	Radial Mini GWS6-115-GWS6-125
RB-1004	Bosch	1604010633	Radial Mini GWS7-115-GWS7-125-GWS8-115-125
RB-1005	Bosch	1604010660	Radial Mini GWS9-125-GWS10-125-GWS14-125 ( L-C )
RB-1006	Bosch	1604010654	Radial Mini GWS14-150C
RB-1007	Bosch	1604010259	Radial PWS6-115-PWS7-125
RB-1008	Bosch	1614011072	Martillo GSH-11E-GBH-11DE
RB-1009	Bosch	1617220073	Martillo GSH-10C-GBH-10C
RB-1010	Bosch	1614011019	Martillo 11305-USH10
RB-1011	Bosch	2610991398	Martillo 11304-USH27
RB-1012	Bosch	1614011098	Martillo GSH-5-5E-5CE-GBH5-40DE
RB-1013	Bosch	1614010128	Martillo GBH-4DSC-GBH-4DFE
RB-1014	Bosch	1614010186	Martillo GBH-5DCE-GSH-5CE-GSH-4
RB-1015	Bosch	1614010052	Martillo GBH2-20-UBH2-20-PBH-14 Taladro GSB18-2
RB-1016	Bosch	1617000524	Martillo GBH2-22S-GBH2-22E-GBH2-22RE
RB-1017	Bosch	1614010732	Martillo GBH2-24-GBH2S-GBH2SE
RB-1018	Bosch	2604010744	Taladro GSB20-2-GSB18-2E
RB-1019	Bosch	1614011083	Martillo GSH3-88
RB-1020	Bosch	1614011091	Martillo GSH 27



## > Nuevos inducidos adaptables



REFER.	Marca	Ref. Original	Adaptable
RH-1030	Hitachi	360591	Martillo H40MR
RH-1031	Hitachi	360360	Martillo H41SA-SC-H45MA
RH-1032	Hitachi	360571	Martillo H45MR
RH-1033	Hitachi	985472	Martillo H55SA
RH-1034	Hitachi	360286	Martillo H65SB-SC-SD-H70SA
RH-1035	Hitachi	360608	Martillo PR38E
RH-1036	Hitachi	360375	Radial Mini G12SE
RH-1037	Hitachi	360603	Radial Mini G12SE2-G13SE2
RH-1038	Hitachi	360287LD	Radial G18SE2-SG-UA-UB-G23SC2-SE-UA
RH-1039	Hitachi	360594L	Radial G23SE2-G23SE3 G23SC-3-G23MR
RH-1040	Hitachi	360288CD	Radial G23SF
RH-1041	Hitachi	360558C	Radial G23SF2-G18SH/U
RH-1042	Hitachi	360149	Martillo DH22VB-DH24VB
RH-1043	Hitachi	360691	Martillo H60MR
RH-1044	Hitachi	360720	Martillo DH24PB3
RL-1045	Legna	SR250	Ingletadora SR250
RL-1046	Legna	SR300	Ingletadora SR300
RL-1047	Legna	U-690	U-690
RM-1050	Makita	511938-9	1900B-1923B
RM-1051	Makita	511763-8	Atornillador 6800DBV
RM-1052	Makita	516708-1	Radial 9049

## > Nuevos inducidos adaptables



REFER.	Marca	Ref. Original	Adaptable
RM-1053	Makita	516773-0	Radial 9067-9069
RM-1054	Makita	512405-7	Lijadora 9218SB
RM-1055	Makita	516803-7	Martillo HM1202C
RM-1056	Makita	516864-7	Martillo HM1304-1304B
RM-1057	Makita	517403-6	HR2410
RM-1058	Makita	516778-0	HR5001C
RM-1060	Metabo	31000640	SB-650/2S
RM-1061	Metabo	31000768	Radial Mini W7-115-125-WPS7-115-125
RM-1062	Metabo	31000776	Radial Mini W10-125-150
RM-1063	Metabo	31000702	Radial W21-230-2030-2032-2080
RA-1070	AEG	307750	Martillo PHE-20RL-PHE-25E-PH-20N-PN2000-2020
RB-1074	Baier		Rozadora MF500
RS-1085	Stayer	SA-10	Radial SA-10
SB-2000	Bosch	1614220121	Estator Martillo GSH-11E-GBH-11DE
SB-2001	Bosch	1604220380	Estator Radial GWS18-230-GWS20-230
SB-2002	Bosch	1604220381	Estator Radial GWS23-230-GWS24-230-GWS26-230
SH-2005	Hitachi	985471	Estator Martillo H55SA
SH-2006	Hitachi	340259	Estator Martillo H65SB
SL-2010	Legna	SR250	Estator Ingletadora SR250
SL-2011	Legna	SR300	Estator Ingletadora SR300
CB-2015	Bosch	GSH11E	Corona GSH11E

## > Rebobinado de inducidos y bobinas



Se rebobinan toda clase de inducidos y estator de toda clase de máquinas, herramientas y motores especiales universales. Así mismo, bajo demanda, se facilitan toda clase de repuestos como piñones, coronas, ejes y demas piezas de cualquier marca que nos soliciten.

Aeg	B & D	Bosch	Casals	Farco T.	Fein
Felisatti	Festo	Flex	Hilti	Hitachi	Kango
Kress	Legna	Makita	Metabo	Perles	Rupes
Ryobi	Skil	Stayer	Virutx	Varios	

## > Tiza limpieza colectores



<b>REFER.</b>
9010





## Bases 16 amp.

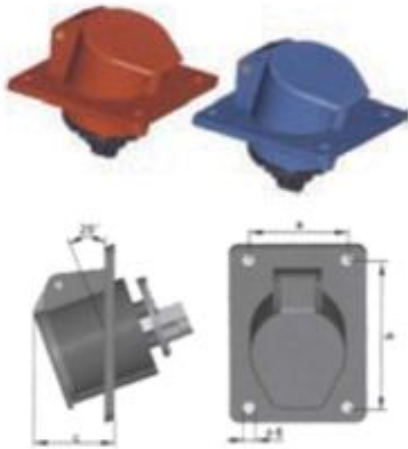

REFER.	Color	Voltaje	Dimensión
SA-113	2P+E - Azul	220-250V	50-65-43
SA-114	3P+E - Rojo	380-450V	50-65-43
SA-115	3P+N+E - Rojo	220-380/240-415V	50-73-45

REFER.	Color	Voltaje	Dimensión
SS-13	2P+E - Azul	220-250V	46-28
SS-14	3P+E - Rojo	380-450V	50-26
SS-15	3P+N+E - Rojo	220-380/240-415V	47-28

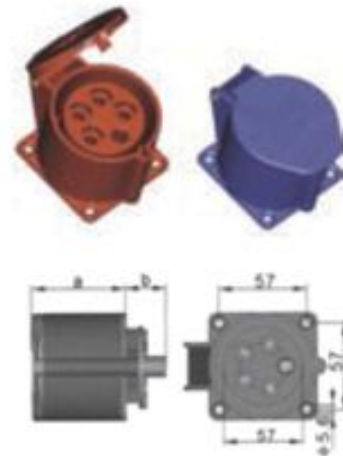

## Clavijas 16 amp.



REFER.	Color	Voltaje	Dimensión
C-113	2P+E - Azul	220-250V	130-70
C-114	3P+E - Rojo	380-450V	131-79
C-115	3P+N+E - Rojo	220-380/240-415V	139-86

REFER.	Color	Voltaje	Dimensión
P-113	2P+E - Azul	220-250V	125-89-47
P-114	3P+E - Rojo	380-450V	125-89-52
P-115	3P+N+E - Rojo	220-380/240-415V	131-95-63



> **Cables máquinas electroportátiles**



<b>C-204</b>	<b>C-206</b>	<b>C-213</b>
4 metros 2x1,5	6 metros 2x1,5	3 metros 2x1,5



<b>C-314</b>
4 metros 3x1,5



<b>C-214</b>	<b>C-205</b>	<b>C-203</b>
4 metros 2x1	5 metros 2x1	3 metros 2x1



<b>C-304</b>
4 metros 3x1

> **Cables manguera goma (rollo 100 mts)**



REFER.	Medida
C-100	2x1
C-100	2x1,5
C-100	3x1
C-100	3x1,5
C-100	4x1,5

## > Fabricación y reparación de resistencias

Resistencias calefactoras para calderas eléctricas



Elementos aleteados



Resistencias para horno y estufa



## > Fabricación y reparación puentes rectificadores

### Características

$V_{RPM}$  Diodos: 400 V.  
 $I_N$ : 230 A (100% E.D., TA=35°C, Vaire=6m/s)  
 Varistor incluido

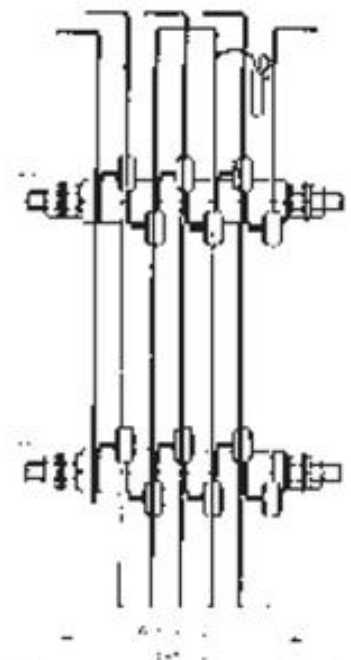
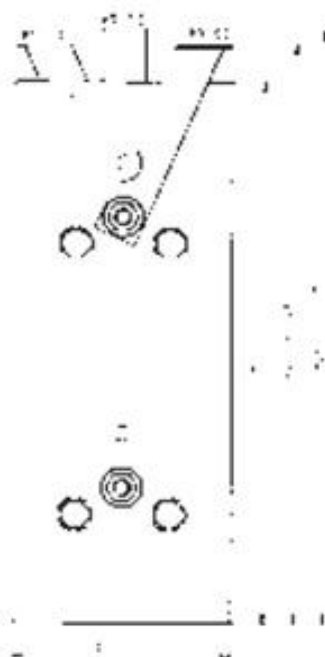



## > Interruptor cambio velocidad



16 AMPERIOS	
MONOFASICO	3 HP
TRIFASICO	7,5 HP

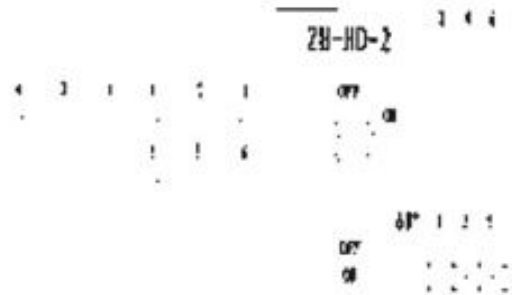

## > Interruptor inversor

16 AMPERIOS	
MONOFASICO	3 HP
TRIFASICO	7,5 HP



## > Interruptores de paquete

Fabricación bajo plano o muestra



## > Manguitos máquinas electroportátiles



> **Interruptores máquinas electroportátiles**





> **Interruptores máquinas electroportátiles**



> **Interruptores máquinas electroportátiles**



**> Interruptores máquinas electroportátiles**





> **Interruptores máquinas electroportátiles**



> **Interruptores máquinas electroportátiles**



**IT220**  
Metabo



**IT232**  
Metabo



**IT235**  
Metabo



**IT236**  
Metabo-Waker



**IT153**  
Distancia aguj. 65



**IT154**  
Felisatti



**IT155**  
Distancia aguj. 65



**IT202**  
Distancia aguj. 62



**IT265**  
Pulsador. Distancia aguj. 55



**IT266**  
Felisatti



**IT267**  
Protector plástico



**IT271**  
Distancia aguj. 58



**IT125**  
Aeg-Legna-Virutex



**IT165**  
Virutex



**IT201**  
Virutex



**IT221**  
Virutex

> **Interruptores máquinas electroportátiles**



**IT287**  
Virutex KJD-17. 5 T



**IT168**  
Berguin



**IT258**  
kango



**IT151**  
Legna



**IT157**  
Rupes



**IT222**  
Stayer



**IT167**  
Universal



**IT177**  
Hormigonera



**IT224**  
Hormigonera 4 T.



**IT225**  
Hormigonera 6 T.



**IT237**  
KOA-24 Monof.



**IT237P**  
Hormigonera M. Term.



**IT238**  
KOA1Y-Trif.



**IT240**  
Balancín Bobina



**IT241**  
KJD-17. 4 Term.



**IT256**  
Interruptor 3 P.



> **Interruptores máquinas electroportátiles**



## > Equivalencias interruptores

Máquina	Refer.	Máquina	Refer.	Máquina	Refer.	Máquina	Refer.
<b>AEG</b>		PH24	IT218	WS230N	IT122	KG72	IT210
AG650/115	IT204	PH26	IT218	WS600	IT204	KG90	IT210
AG680/115	IT212	PHE16RLN	IT219	WS601	IT204	P5411	IT187
AG710/100	IT204	PHE20RLN2	IT219	WS602	IT204	P5721	IT186
AG710/125	IT204	PHLE20R	IT219	WS630	IT204	P5722	IT186
AG715/100	IT212	PJ710	IT212	WS632	IT204	PL85	IT186
AG715/115	IT212	PKN1,6	IT204	WS650/115	IT212		
AG715/125	IT212	PKN1,6	IT212	WS660/115	IT204	<b>BOSCH</b>	
AG8/115	IT212	PKN1,6L	IT204	WS710/115	IT204	CSB450-2	IT108
AG8/125	IT212	PN2000-2	IT219	WS710/125	IT204	CSB480RE	IT109
AG805/115	IT212	PN2000N	IT219	WS7-115	IT212	CSB500-2	IT114
AG805/125	IT212	PN2600R	IT217	WS7-125	IT212	CSB500RE	IT109
AGV805/125	IT212	PN3000X2	IT217	WS715/115	IT212	CSB500RLE	IT109
B450	IT118	S230-2300	IT188	WS715/125	IT212	CSB500SRE	IT109
B500	IT218	SB2-10	IT215	WS8-115	IT212	CSB5-13RE	IT109
BHE7-26	IT217	SB2-13	IT215	WS8-125	IT212	CSB550-2	IT114
D10	IT118	SB2-16	IT214	WSA1201	IT122	CSB550RE	IT109
D10N	IT118	SB2-16N	IT118	WSA1800	IT122	CSB550SRE	IT109
D2-10	IT214	SB2-18	IT218	WSA1900	IT122	CSB570RE	IT109
DMB2300	IT188	SB2-19	IT218	WSA1900	IT188	GAH-500	IT227
DME65	IT188	SB2-35	IT118	WSA2100	IT122	GBH-2	IT227
EX400	IT118	SB2-400N	IT215	WSA2100	IT188	GBH2/24DRS	IT109
EX450/125	IT118	SB2-400S	IT215	WSA2300	IT122	GBH2-24	IT227
FSPE100	IT213	SB2-500	IT215	WSA2300	IT188	GBM10	IT179
FSPE80	IT213	SB2-500L	IT215	WSA2300X	IT188	GBM-10	IT227
GS400	IT204	SB2-500S	IT215	WSA230S	IT188	GBM10-2	IT179
GS400	IT212	SB2-550	IT214	WSAM1900	IT188	GBM10-2RE	IT109
GS500E	IT212	SB2-550	IT215	WSCE800/115	IT213	GBM13	IT179
GSL500	IT204	SB2-570	IT214	WSCE800/125	IT213	GBM13-2	IT231
GSL500	IT212	SB2-600	IT118	WSE180	IT122	GBM13-2RE	IT109
GSL600E	IT212	SB2-630	IT214	WSE800	IT213	GBM350	IT179
JSPE90X	IT212	SB2-700	IT218	WSE800/125	IT212	GBM-6	IT227
KM10	IT118	SB2-700D	IT118	WSE8-125	IT212	GBR14C	IT253
KN2	IT204	SB2E850RS	IT217	WSE9/125	IT212	GEB1000	IT111
KN2	IT212	SSPE800	IT118	WSL100	IT204	GEX150	IT111
KNS2	IT204	STEP800X	IT212	WSL115	IT204	GFF22	IT229
KNS2,5	IT204	TX125	IT118	WSL125S	IT204	GG27	IT110
KS1,6	IT204	UH600	IT219	WSL180	IT188	GG27	IT110
KS1,6	IT212	USLE125	IT213	WSL230	IT188	GG27	IT111
KS2,5	IT204	USS230	IT118	WSL600	IT204	GG7	IT111
KS2,5	IT212	VS230	IT118	WSLE115	IT213	GNA1,6	IT111
LF650	IT212	VSL20	IT118	WSLE125	IT213	GNA3,2	IT110
MSF230	IT188	VSS22	IT118	WSLE800/115	IT212	GNA3,5	IT111
OF450S	IT204	VSS260	IT118			GNF20	IT111
OF500S	IT212	WP1900	IT122	<b>B&amp;D / DEWALD</b>		GNS14	IT115
OFE630	IT213	WS180N	IT122	DW479	IT186	GRS18RE	IT109
OFE710	IT212	WS1900	IT122	DW490	IT186	GSB13RE	IT255
OFSE630	IT213	WS1900	IT188	DW811	IT187	GSB16RE	IT109
PD2-10	IT214	WS2100	IT122	DW816	IT187	GSB18-2	IT227
PD2-13	IT214	WS2100	IT188	DW852	IT186	GSB18-2	IT231
PDE16RPQ	IT216	WS2300	IT122	KG11	IT187	GSB18-2RE	IT109
PH20N	IT118	WS2300	IT188	KG65	IT210	GSB2000	IT109



Máquina	Refer.	Máquina	Refer.	Máquina	Refer.	Máquina	Refer.
GSB20-2	IT227	GWS24-180	IT115	PSB15RE	IT255	DH18VB	IT262
GSB20-2	IT231	GWS24-180	IT228	PSB16RE	IT255	DH20PB	IT259
GSB20-2RE	IT109	GWS24-180JH	IT234	PSB400	IT231	DH22VB	IT262
GSB2-600RE	IT109	GWS24-230	IT115	PSB420	IT179	DH24PA	IT261
GSB2-650RE	IT109	GWS24-230	IT228	PSB420-2	IT114	DH24PB	IT259
GSB400	IT231	GWS24-230JB	IT234	PSB450-2	IT230	DH24PB3	IT278
GSB650RE	IT255	GWS24-230JH	IT234	PSB500R	IT109	DH24PC	IT259
GSC160	IT229	GWS24-300	IT115	PSB500RE	IT255	DH24PD	IT259
GSR5-11	IT179	GWS25-180	IT228	PSB5-15RE	IT255	DH24VB	IT262
GSR6-16TE	IT109	GWS25-180J	IT234	PSB530RE	IT255	DH25PB	IT276
GST60	IT110	GWS25-230	IT228	PSB550RE	IT109	DSV8	IT248
GST80	IT110	GWS25-230J	IT234	PSB550RE	IT114	DUT13	IT275
GST85	IT110	GWS26-180	IT228	PSB570RE	IT255	DV20VB	IT259
GSZ160	IT229	GWS26-180JB	IT234	PSB580RE	IT255	DV20VC	IT274
GUF22	IT111	GWS26-230	IT228	PSB600-2	IT230	DV22VB	IT262
GUF4-22	IT111	GWS26-230JB	IT234	PSB600RE	IT255	DV24VB	IT262
GWS10-125	IT111	GWS26-230JB	IT234	PSB60A	IT231	DVR10	IT248
GWS10-125	IT253	GWS5-100	IT229	PSB6-16RE	IT255	DW15Y	IT248
GWS14-125	IT253	GWS6-115	IT229	PSB650-2	IT230	FCJ55VA	IT250
GWS14-150	IT253	GWS6-125	IT229	PSB650-2	IT255	FCJ65V	IT250
GWS180J	IT234	GWS650	IT111	PSB650RE	IT255	FDV16V	IT250
GWS18-180	IT115	GWS660	IT229	PSB6RE	IT255	FDV16VA	IT250
GWS18-230	IT115	GWS7-115	IT111	PSF22	IT111	FDV20VB	IT259
GWS18U	IT115	GWS7-115	IT254	PST53	IT231	G10SD2	IT249
GWS19-180	IT115	GWS7-125	IT111	PST54	IT231	G12S2	IT249
GWS19-230	IT115	GWS8-115	IT229	PWS10-125	IT253	G13SE	IT273
GWS20	IT228	GWS8-125	IT229	PWS115	IT110	G18SE2	IT209
GWS2000-230	IT115	GWS9-125	IT111	PWS13-125	IT253	G18SG	IT209
GWS2000-23J	IT234	GWS9-125	IT254	PWS1700	IT115	G18SH	IT209
GWS200-18J	IT234	GWS9-150	IT111	PWS1800	IT228	G23SC	IT209
GWS20-180	IT115	M21S	IT113	PWS18-230	IT115	G23SE	IT209
GWS20-180	IT228	M41S	IT113	PWS1900	IT234	G23SF	IT260
GWS20-180J	IT234	M42SB	IT113	PWS20-230	IT115	UT5V	IT248
GWS20-180JH	IT234	OSB1020	IT111	PWS20-230	IT228	V6VB	IT248
GWS20-230	IT115	PAM500	IT110	PWS20-230J	IT234	V6VE	IT248
GWS20-230	IT228	PBH-14	IT227	PWS500	IT111	VTV13K	IT248
GWS20-230J	IT234	PBH160	IT179	PWS5-115	IT111	VTV18	IT248
GWS20-230JH	IT234	PBH16RE	IT109	PWS550	IT111	W6V3	IT259
GWS21-180	IT115	PBH1R	IT109	PWS600	IT111	W6VA2	IT247
GWS21-180	IT228	PBH-200	IT227	PWS6-100	IT111	W6VA3	IT259
GWS21-180JH	IT234	PBH200FRE	IT109	PWS6-115	IT111	W6VB2	IT259
GWS21-230	IT115	PBH200RE	IT109	PWS620	IT111		
GWS21-230	IT228	PBH200RF	IT109	PWS700	IT111		
GWS21-230JH	IT234	PBH20RLE	IT109	PWS710	IT111	<b>MAKITA</b>	
GWS21U	IT115	PBH2R	IT109	PWS7-115	IT111	1202	IT180
GWS230	IT228	PBM400	IT179	PWS7-125	IT111	1223	IT180
GWS2300-23J	IT234	PBM550	IT179	RLE	IT227	1901	IT180
GWS230J	IT234	PEX115	IT114	UBH2/20RLE	IT109	1902	IT180
GWS23-180	IT115	PEX125	IT114	UBH2-20	IT227	1923	IT180
GWS23-180	IT228	PKF25	IT110	USH10	IT174	2030	IT243
GWS23-180J	IT234	POF500	IT110	HITACHI		2031	IT243
GWS23-230	IT115	POF52	IT110	D10VC	IT248	2033	IT243
GWS23-230	IT228	POF600	IT111	D10VC2	IT277	2414	IT245
GWS23-230J	IT234	PSB13R	IT109	D13V	IT248	4014	IT244
GWS23-230J	IT234	PSB13RE	IT255	D13VB2	IT259	4304	IT245
						4306	IT245



Máquina	Refer.	Máquina	Refer.	Máquina	Refer.	Máquina	Refer.
4322	IT272	HP2033	IT243	SB620-2	IT148	181N	IT221
4323	IT272	HP2040	IT243	SB650-2	IT211	AB11	IT221
4324	IT272	HP2041	IT243	SBE521-2	IT220	AB11C	IT221
4901	IT272	HR2000	IT244	SBE550	IT235	AF11	IT165
5017	IT245	HR2020	IT280	SBE600	IT235	AI97	IT101
5020	IT272	HR2410	IT279	SBE655-2	IT220	AI97N	IT221
5021	IT272	HR2420	IT279	SBE680-2	IT220	AJ97	IT201
5603	IT245	HR2440	IT280	SR220	IT148	AL96	IT201
5703	IT245	HR2450	IT280	SR326	IT232	AS93	IT201
6030	IT272	HR3000	IT245	SR328	IT232	B65	IT125
6410	IT243	HR3500	IT242	SR355	IT232	C67	IT125
6501	IT180	HR3520	IT242	SR356	IT232	C93	IT101
6510	IT244	HR3850	IT242	SR358	IT232	C93N	IT221
6800	IT244	HR4000	IT245	SR4320	IT148	CE89C	IT201
6802	IT244	HR4500	IT245	SR4350	IT232	CR94D	IT221
6805	IT244	HR5000	IT242	SRE329	IT232	DE87C	IT221
6807	IT243	HR5001	IT245	SRE357	IT232	E70N	IT190
6820	IT244	JR3000	IT244	SRE359	IT232	F71	IT190
6821	IT243			STEP450	IT148	FR117N	IT221
6822	IT244			STEP455	IT148	FR29C	IT221
8402	IT263	<b>METABO</b>		STEP461	IT148	FR29K	IT221
8406	IT245	B480	IT148	STEP550	IT148	FR29M	IT221
8450	IT243	B481	IT148	STEP560	IT148	FR56E	IT221
8451	IT243	B500	IT148	STEP565	IT148	FR77C	IT101
9015	IT184	B650-2	IT148	STEP600	IT148	FR78C	IT101
9016	IT184	B650-2	IT211	STEP650	IT148	FR92C	IT221
9029	IT184	BE604	IT235	STEP700	IT147	H71	IT201
9037	IT184	BH6008	IT211	SXE2000	IT232	K75	IT201
9039	IT184	BHE20	IT220	SXE425	IT232	L75	IT165
9047	IT184	BHE6011	IT220	SXE450	IT232	LB31E	IT201
9049	IT184	EW10125	IT147	TR23300	IT150	LR86C	IT201
9059	IT184	EW115	IT147	W19180	IT150	LRE86C	IT201
9067	IT184	EW125	IT147	W19230	IT150	M75	IT201
9069	IT184	EW6114	IT147	W20180	IT150	O81	IT101
9218	IT180	EW7025	IT147	W20230	IT150	O81N	IT221
BO3700	IT272	EW7100	IT147	W2030	IT208	P75	IT190
BO4533	IT246	EW7115	IT147	W2080	IT208	RA17D	IT221
BO4561	IT246	EW7117	IT147	W21180	IT150	RO56D	IT221
BO4563	IT246	EW7126	IT147	W21-180	IT208	RT88C	IT221
BO5050	IT246	EW7127	IT147	W21230	IT150	RT91C	IT201
DA302D	IT263	EWE11125	IT147	W21-230	IT208	RZ70M	IT221
DA391D	IT263	EWE11150	IT147	W2230	IT208	TM33E	IT201
HM1200	IT242	EWE1150	IT147	W2280	IT208	TM33H	IT201
HM1300	IT242	EWE125	IT147	W23180	IT150	TM43D	IT201
HM1303	IT245	EWE7116	IT147	W23-180	IT208	TM43J	IT201
HM1400	IT281	EWE9024	IT147	W23230	IT150	TM43L	IT201
HM1500	IT242	EWE9123	IT147	W23-230	IT208	TS33E	IT201
HM1800	IT281	EWE9125	IT147	W25180	IT150	TS33H	IT201
HM1810	IT281	GSE6145	IT147	W25230	IT150	TS48D	IT201
HP1500	IT243	GSE7141	IT147	W25-230	IT208	TS48J	IT201
HP1501	IT243	GSE7145	IT147	W2530	IT208	TS48L	IT201
HP2010	IT244	LF714	IT147	W75	IT208	Z81	IT101
HP2020	IT244	MFE1125	IT147			Z81N	IT221
HP2030	IT243	MH10S	IT236	<b>VIRUTEX</b>			
HP2031	IT243	MHE10S	IT236	181	IT101		
		PE7175	IT147				

## > Escobillas - Presentación

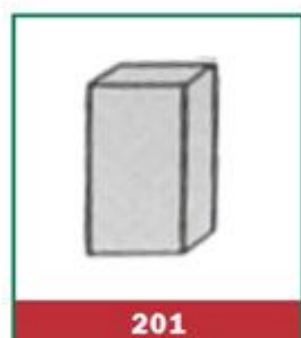



## > Portaescobillas

**A.** Ancho alojamiento carbón

**C.** Dist. de centro de bulón a centro aloj. escobilla

**B.** Grueso alojamiento carbón

**D.** Diámetro del bulón

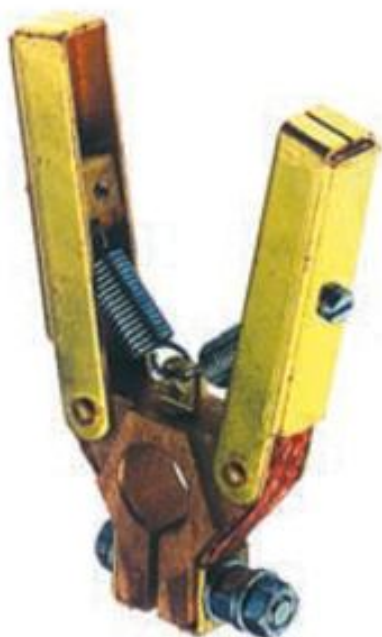

REFER.	A	B	C	D	Esc. mm.
203	12	6	50	10	12 x 6
203-1	12	7	50	10	12 x 7
203-2	12	8	50	10	12 x 8

REFER.	A	B	C	D	Esc. mm.
1212	16	8	60	12 a 16	16 x 8
1212-1	20	8	60	12 a 16	20 x 8
1212-2	20	10	60	12 a 16	20 x 10
1212-3	22	10	60	12 a 16	22 x 10
1212-4	22	10	65	12 a 16	22 x 10
1212-5	22	10	72	12 a 16	22 x 10
1212-6	25	10	80	12 a 16	25 x 10
1212-7	25	12	85	12 a 16	25 x 12
1212-8	36	12	94	18	36 x 12
1212-9	36	12	110	20	36 x 12
1212-10	44	16	140	22	44 x 16

REFER.	A	B	C	D	Esc. mm.
400	28	12	60	16	28 x 12
400-1	32	16	70	25	32 x 16
400-2	40	20	80	25	40 x 20



REFER.	A	B	C	D	Esc. mm.
300	32	16	51	25	32 x 16
300-1	40	20	52	25	40 x 20
300-2	50	20	57	25	50 x 20



## > Portaescobillas

**A.** Ancho alojamiento carbón

**B.** Grueso alojamiento carbón

**C.** Dist. de centro de bulón a centro aloj. escobilla

**D.** Diámetro del bulón



REFER.	A	B	C	D	Esc. mm.
1232	16	8	50	13	16 x 8
1232-1	22	8	60	16	22 x 8
1232-2	22	8	80	16	22 x 8
1232-3	28	10	97	18	28 x 10
1232-4	36	12	94	18	36 x 12
1232-5	36	12	110	20	36 x 12
1232-6	44	16	140	22	44 x 16



REFER.	A	B	C	Esc. mm.
201	25	10	15	25 x 10
201-1	25	12,5	16	25 x 12,5
201-2	25	16	18	25 x 16
201-3	25	20	20	25 x 20
201-4	32	10	15,5	32 x 10
201-5	32	12,5	16,5	32 x 12,5
201-6	32	16	18,5	32 x 16
201-7	32	20	20,5	32 x 20



REFER.	A	B	C	D	Esc. mm.
207	20	8	65	13-14	20 x 8
207-1	25	8	65	13-14	25 x 8
207-2	20	10	65	13-14	20 x 10
207-3	25	10	65	13-14	25 x 10
207-4	25	12	65	13-14-15	25 x 12
207-5	28	12	65	13-14-15	28 x 12
207-6	32	12	65	13-14-15	32 x 12

Este tipo se fabrica con un solo brazo.



Figura	Ref.	Medidas	Original	Aplicaciones
	1300	5 * 8 * 15	218605 218606 272708	Atomillador EBS4BS6A Taladro SBE350-380-SB2.400-480-SB2E.380-400-SB2E.450 SB2EA.450-480-500-B2.400-480-B6-BE6A-8-BWE6 SB401RL-SBE420RL-500RLS-SB2.16-500S-13RL SB2E500RL-SB2E600RL-SB2E620RL
	E338 E1338	6,3 * 6,3 * 11,5	320625 320626	Atomillador TC18E1-TCE1800 Martillo PHE16RLN-PHE20R-P2000-P2000TU-SBE480R Taladro SB6.500R Taladro percusión SBE10RLN-BE10RLN-SBE380R-400R-450 SBE500R-SBE500RT-SB2.400N-SB2.500-USB380E-USB520E
	E340 E1340	5 * 8 * 14	301871 301872 361733	Atomillador UBSE8RL-UBSE8RL Cepillo H500 Lijadora orbital VSSE20-VSS20-VS230-VS14-VSE20-VSS230 Martillo PHE20RLN/RLN2-PHE20RLMF2 Sierra de calar STS380A-STPE400-400A-STSE400A-STPE500 Taladro percusión BE13RLN-BE13RLDLC-SB2EIGRL Taladro SB2E650R-SB218-SBE18R
	E351 E1351	6,3 * 6,3 * 15	313481	Lijadora banda HB6E65-HBS65
	E301 E1301	5 * 10 * 18	221930	Atomillador BS10A Roscadora G10A Taladro SB2E600-680-750-600-SB4.500-SB4.550-SB2E16 SB2E451RL-501-SB2.401-420S-501-350RL-380RL-420
	E302 E1302	5 * 8 * 14	306842 310684 310685	Lijadora de vaivén VS350 Recorta-setos HES40/50/65 Sierra de calar STS330-ST3350-ST32330-STSE60-STPE60 Taladro percusión SB2.16N Taladro SBE15R-18R-520R-SB2.16N-600-550-650-700-SP2.16
	E305 E1305	5 * 10 * 15,5	271396 301359	Cepillo H750-HB750-EH102-EH821MEF82.1- Lijadora orbital VS280-VSS280-VSSE280-VSS20/22-VSSE20/2 Sierra sable SSPE800M Taladro B2E13RLD+E48 Taladro percusión SB235D-SB2E20/20RL-SB2E1001RL Taladro SB2E.601RL-SB2E.701-SB2E.751-801-801RL-1001 Taladro percusión SB2E.1001RL
	E306 E1306	5 * 10 * 17	216237	Sierra de calar STSE350 Martillo OX160-PHE16-PHE16N-PHE20RL-PHE20RLN Taladro SB2.35D-SB2E20-20RL-651-701-751-801-901-1001 SB2E1001RL-B16-B2.16-BZ16A-BV16A
	E1319	5 * 10 * 16,5	225677 216239 328960	Cepillo EH82-HBE800-HE800 Lijadora de vaivén VS250-VSS250 Sierra circular HK125A-HK55S/SE-HK66SE





## Aeg-Milwaukee

Figura	Ref.	Medidas	Original	Aplicaciones
	E314 E1314	5 * 12 * 16	224706	Cepillo HTH75 Sierra circular HK160A
	E316 E1316	6,4 * 12,5 * 17	220349	Lijadora de banda HBS2110 Sierra circular HK190-201
	E323 E1323	6 * 13 * 17	238144	Sierra circular HK240
	E327 E1327	5 * 10 * 11,5	247113	Martillo BH25S-0X200-250-260-360-PH38-200-240D-350-26
	E345 E1345	6,3 * 10 * 15	303777	Sierra circular HKS52-HKS66-HKSE66-HKE66-HK66 Taladro percusión FBE/MDBE
	E304	5 * 8 * 15	214722 242603	Atomillador ESB6/8 Taladro SB2.420-SB16-B8A-BZ10A-BZ10B-B10-B10A-B10B
	E1307	6,4 * 12,5 * 20	222556 248924	Esmeriladora angular WS900-1700 Radial WS2300-WSA2300-WSB2300-WSBA2300 Pulidora angular WPZ450 Taladro BZ22-BV26/32-BWZ16-B4.26/32-B4-32
	E1312	8 * 16 * 25	210293 216147	Esmeriladora angular WSA2000-WSB-WSBA2000 Radial WS1900-2000S-2100-2100S-2300S-A1900-2000S-2100S WSA2100-2300S-WSB1900-2100-2100S-WSBA1900-2100 WSBA2100S-WSC2300S Sierra de cadena KES36
	E1324	5 * 10 * 21	211295	Pulidora angular WP400
	E325	5 * 8 * 20	211259	Cizalla KS2.5 Pulidora angular WP250 Radial recta GSZ250-GSZ420
	E308	4 * 6,4 * 11,5	223422	Radial angular WS330
	E332	5 * 8 * 10	392563	Taladro y Martillo
	E342 E1342	6,4 * 10 * 15	275820	Sierrasable KS35
	E355 E1355	6 * 9 * 24,5	316665	Aspirador NTE900-NT900
	E372	6,3 * 8 * 11,5	22180915	Taladro HDE13RQD





## Aeg-Milwaukee

Figura	Ref.	Medidas	Original	Aplicaciones
	E309 E1309	5 * 8 * 15  FH2,8	279375 279376 305420 305421 318213 318214 369475	Fresadora OF450-OF450S-OFE500-OFE500S-OME500 Lijadora orbital VSS260-VS260-VS360 Radial SE800M-S600-UWS630-WS115-125-600-601-2-630-631 WS632-710/115-710/125-WSE115-125-601M-WSE602M WSE800C-800M-801-802-WSL115-115XS-WSLE115 WSL125S-WSLE125-WSL600 Radial mini GS400-GSL500-VSL115-VSLE115-VSLE125 Sierra de calar FSTE60-FSPE100X-BSP100A/X-FSP100X Tijeras KSS1.6-KSS2.5-KNS2
	E1366	5 * 10 * 16  FH4,8	322155 326941 343911 360787 369477	Radial WSE1200C-1300-WS1000-WSCE1300-WSL125XL Taladro SBE20R-SBE22R-SB2E24RT-DKE1300 Martillo PN3000X2-PHE26R-PHE26-PHE30RX2-26RX2 PN3500-X-3000X2-PH30RX-PHE3X-PHE3550RX2 Radial AG1200/125X-AG1300/125XC Taladro SB2E20RA/RS-800RS-1000RS-SB2E22R-SB2E24RT Martillo PHE350RX2-PN3000SUBX2-PN3500-3500Z-PH3 PH350RX2-PH3X-PHE26RX2 Radial AG10-125-12-125-16-125-16-180 Pulidora AP12
	E310 E1310	5 * 10 * 17  FH4,8	237258	Radial angular WS480-WS500-WS550
	E321 E1321	5 * 10 * 16	268860 310560 339755	Martillo DX225-PH200-PHE20-PHE26-PHE200 Martillo percusión PHE26SDS Radial WS75L
	E333 E1333	5 * 8 * 15,5  FH2,8	244937	Sierra orbital VSS260-VSSE260
	E358 E1358	8 * 14 * 20  FH6,3	329116 329117 369479	Radial WSA2100-WSA2300
	E317	5 * 5 * 12	305155	Cortasetos HS40-HS50-HS60-HS70 Lijadora orbital VS130 Sierra de calar STS250-STSE250
	E399.11	6,3 * 8 * 12	359940	Atomillador TQSE-1000-2500
	E399.6	6,3 * 8 * 12  muelle	354545	Sierra



## Aeg-Milwaukee











Figura	Ref.	Medidas	Original	Aplicaciones
	E320 E1320	6,3 * 12,5 * 20	259493 259495 259496 369476	Radial S230-TSDA2000-WS180N-190S-230N-230S-1800-1801 WS1900-2000N-2001-WSA1800-1801-1900-2000N-2001 WSB180S-230N-230S-1800-1801-WSBA1800-1900-2000 WSE2300-WSE2301-WSL180-WSL230
	E331 E1331	6,4 * 10 * 16	279612 279613 369480	Pulidora WP1900-WSA1201/1200-WSE180 Radial WS1201
	E357 E1357	6,3 * 10 * 20 FHB4,8	321940	Martillo PHM
	E1322	6,3 * 12,5 * 15,5	259022	Sierra circular HK65A-75-75A-575-5055-55A-65-66SHKS75
	E334 E1334	5 * 10 * 16,5	272662	Cepillo EH700-EH700R-EH822-EH825
	E348 E1348	8 * 9 * 15	311688	Fresadora OFEG50-OFEG30-OF550-OF550
	E335 E1335	6,4 * 9,5 * 16	278702	Lijadora de banda HBSE100-HBS100-BBS100-BBSE100
	E326	5,4 * 7 * 9	376574	Taladro P18t-S14,4TS12T-PES12T-PES9,6T-PAD12 Roedora PN12PP Sierras sable PSX18
	E1361	5 * 8 * 16,5	358319	Radial AG805-125XE/115XE/125XC-715/125X/115X/100 Taladro SB218-SB22
	E1337	5 * 8 * 15 FH2,8	392612	Radial angular
	E1362	5 * 8 * 15	341881	Radial WSLE115
	E453	6,3 * 8 * 18 FHB4,8	302211	Martillo PH5-PH5H-PHE5H-PB65
	E373	6 * 9 * 15,5 FH2,8	4931.393322	Mini Radial WS6-100-WS6-115-WS6-125+E53
	E371	5 * 10 * 13 FH2,8	2218.1320	Atomillador DWSE4000Q Taladro HDE6RQ-10RQX-13RQX
	E1370	5,9 * 11,1 * 17,5 FHB4,8	22180875	Martillo PHE45SQ

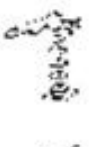



Figura	Ref.	Medidas	Original	Aplicaciones
	E200	6,3 * 11 Redonda	920114 993383 995054	Martillo percutor HD1300 Taladro D400-D500-D520-D640-D700-D720-D820-GD10-GD20
	E201	6,35 * 6,35 * 13	890488 913807	Cepillo BD710-750-BD711-BD713-BD720-DN75-710-730 Cizalla P8401 Lijadora GD47-GD48-P6301 Lijadora banda BD83-BD83E-DN83-DN83E Martillo D10-D13-D108-D112-F7-F8-F10 Sierra de calar DN38-39-BD99E-547E-DN98-99E-547E-PL30 Sierra circular DN230-DN231 Taladro D13PV-D101-102-104VR-200S-201-201S-202-202S-205 D206S-DN50-52-64-72-72V-74-76-DN84-DN84SE
	E205	6,3 * 6,3 * 11	883772 570544	Cotasetos D409A-BDN452-550-552 Lijadora orbital DN44-441-46-47-48 Sierra de calar DN31-34-35-36-521-522-523-524 Sierra circular DN54-55-56 Taladro D206A-D77A-H68RA-VA-VBVC
	E202	6 * 6 * 15	904764	Atomillador HD25D-HV7VAE-18V-7P-25D-25T-SV7V-P7301 Taladro 10HM2PA-2PB-2VA-2VB-13GD2P-2V-13HG2PA 13HG-2VA-2VB-13HM2PA-2PB-2VA-13HM2VB 16HPG2PA-2PB-2VA-2VB8GM8GM/2V-10GM/P
	E204	6 * 8 * 15	731717	Lijadora HD2040HD2120-P6303-P6304-P6305
	E241	6,3 * 6,3 * 13	959775 400818	Lijadora orbital PD6301A-P6302A-PL50A-SR400A
	E206	6,3 * 9,5 * 14	66678-01	Sierra circular 7308-7310-7320-7394
	E210	6 * 6 * 13	203569 937690	Cizalla P8402 Radial SAG500-SAG550-SAG550F-DN10
	E227	5 * 5 * 10	736703 936703	Aspirador BD273 Taladro BD124-169-170-175-180E-273-CP135-DN41-N41A-41A DN41D-49-49E-170-175-180E-273-277E-H41-SR410E
	E228	6,3 * 6,3 * 13,5	930760	Taladro PL10-15-P1142-1144-1145-1146-49-51-67-67A-68-1168 P1169-78-78A-79-P1243-46-49-P2167-68-69-72-77-E207 P2179-P2243-P2246-P2249-EMD402-DN11
	E237	6 * 6 * 10,5	745678	Lima BD280-BD282-BD290-BD292
	E242	6 * 7 * 13	832998	Lijadora orbital BD190-BD190E-BD190S Lima eléctrica BD290 Sierra de calar BD755PE-BD765PE

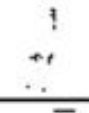







Figura	Ref.	Medidas	Original	Aplicaciones
	E207	6,3 * 12,7 * 19,5	899763	Sierra circular HD2062-75-86-P3701-P3901
	E209	5,9 * 8,3 * 15 FH28	903860 935091	Radial MAG101-MAG102-P5502
	E211	6 * 8 * 16	907904	Cepillo 80PLA-P7101 Lijadora ORS-ORL Pulidora LEM-LUM-6139-6140-P6201-P6601
	E212	7 * 12 * 25	908206 935845	Radial SMEyBSMEyC
	E214	6 * 12 * 20	855196 852664	Radial HD2180-HD2230-HD2150-AG/BAGyC
	E217	6 * 8 * 19,5		Radial ANS Taladro 23-2V
	E239	6,3 * 8 * 14,5	735381	F226TR-F228TE
	E219	3+3 * 12,5 * 32	131602	Aspirador HD5465-01
	E213	6,3 * 12,5 * 25 930558 FH4,8	854500	Radial DN17-18-DN20-G1500-GD3115-GS1600-HD3180-3230
	E236	6 * 8,15 * 15	935091	Radial DN12-P5501
	E222 E1222	6,3 * 8 * 13,5	930151 930897 939539	Radial BD12-14-PL80A2-P5404-5411-5412-5413-5415-5416 P5417-P5426-P5427-P5504-P5512-P5513-P5516-S450
	E966	6,3 * 6,3 * 13 FH2,8	949833-04	Taladro 2271A TIPO 1 P2271A TIPO 3
	E215 E1215	6,3 * 16 * 22,5	908752	Radial P5702-5703-5706-5902-5903-5906-5912-5913-5916 PAG620-620LS-PAG622-PAG622LS-PAG820-PAG822
	E216 E1216	6,35 * 12 * 22	908775	Radial PAG618-P5901-P5911-PAG617-PRO2000











Figura	Ref.	Medidas	Original	Aplicaciones
	E218	6 * 12,5 * 19		Sierra circular HD1215
	E220 E1220	6,3 * 12,5 * 23,5	933371	Radial BD2018-BD2023-DN2023-PL85A-SR283E-P5724-P5732 P5741-P5922-P5924-P5932-P5952-S900 Sierra circular P3902 Tronzadora de disco P3201-P3202
	E221 E1221	6,3 * 16 * 23 FH4,8	933373	Radial P5722-P5752-P5921-P5941-P5933
	E223	6,3 * 9,3 * 15	131743	Martillo percutor 2032
	E224	6 * 8 * 18 FH2,8	320876 323660-00	Martillo BD423-425RE-D423-425RE-P8000-8020-RW500E SR950-ORE5014
	E225	6 * 8 * 18	916368 403485-00 588142-00	Atomillador P7315-P7318-P7319 Radial BD5-BD11-DN5-DN11-PL80-SR800E-P5404-P5416-17 Taladro BD136RS-BDT140RT-230E-230R-240RT-D130R-35R D140RT-152G-154RG-220-230E-R-240RT-SR900-5R
	E226	6,3 * 8 * 16	735381 135948-05 400816-00	Taladro BD308RE-BD309R-310RE-1000-D302E-3E-3R-4E-6E D308E-RLE-9-10E-R-RE-RLE-SR930RLE-935R-40E
	E230	6 * 8 * 16,5	914633 401852-00 401853-00	Ingletadora BD700-BD800-DN57-DN800-810-820-SR300-700 Sierra circular P3703
	E235	6 * 8 * 16,5	917287	Sierra circular DN85-P6103
	E240	6,3 * 6,3 * 12	680495-00 85531-01	8255
	E243	6,5 * 8 * 15 FH2,8	560454-00	KG65-72-90







Figura	Ref.	Medidas	Original	Aplicaciones
	E100	6,4 * 6,4 * 15,5	2604321904 2604321909 2604321912	Atornillador GSR5-11TE-1416-1419-1419.6-1419.7 Cortasetos PSB400RET-PHS36G-PHS46G-PHS66G Lijadora PSS230.E-3238.4 Sierra de calar PST50-50.2-50E-54-PE55-PE60-PEA Taladro CSB420.2-420E-450.2E-500.2E-520.2E-SB350.2
	E109	5 * 8 * 15,5	1617014114 2607014002 2604321905 2604321907 2604321913	Atornillador 1411-11.7-15.7-16.6-16.7-18.7- Cepillo PH015/82-25/82-35/82C-PH050-150-200-GHA500DSR Fresadora POF400A Lijadora PSS28A-AE-GSS230A-280-GEX125A Martillo PBH2RP-160R-GBH2SE-22-24-GAH500-UBH2/14/20 Roedora PFZ500E-PSS28D-PSS28AE Sierra Circular PKS40-46 Taladro 1002VSR-3VSR-20VSR-21VSR-22VSR-26VSR-27VSR 1125-25.7-26-26.7-CSB470RLE-500.2E-RE-550.2-600-20-50 750-800-1000-GMB10.2/2RE-SER-RE.3149-GMB13.2-GSB20.2
	E1109	5 * 8 * 15,5	1607014117	Atornillador 1411-11.7-15.7-16.6-16.7-18.7 Cepillo PH015/82-25/82-35/82C-PH050-150-200-GHA500DSR Taladro 1002VSR-3VSR-20VSR-21VSR-22VSR-26VSR-27VSR 1125-25.7-26-26.7-CSB470RLE-500.2E-RE-550.2-600-20-50 750-800-1000-GMB10.2/2RE-SER-RE.3149-GMB13.2-GSB20.2
	E101	6,4 * 6,4 * 16	1604321900	Fresadora POF50 Lijadora GSS28-PSS230 Radial recta 1204 Sierra de calar P10-P11-P20-P21-P80-1579 Soplador USG380 Taladro 1105.0-1105.8-1105.9-1114-15-1122-1158.7-E22-24SB
	E144	5 * 8 * 15	2607014000	Lijadora GGS16A
	E149	5 * 8 * 15 muelleytern.	2607014001	Lijadora GSS14-GSS16A-PSS23A-PSS23AE-PDX15AE
	E185	5 * 8 * 15,5	2604320914	Sierra de calar GST100-B-BCE-CE
	E102	6,4 * 8 * 16,5	2604320906	Atornillador 1409 Fresadora POF500A Punzonadora GNA2 Radial recta GG27LC
	E103	6,4 * 6,4 * 16	2604320902	Atornillador 1402-03-06-07-08-10-12-13-14-17-32-GSR6.6KE Radial recta 1205-1206-1210-1211-1212-1327-PWF115 Sierra de calar 0575-0576-1577-1578-1580 Taladro 1106-07-08-1123-24-1150-51-57-71-72-75-76-78







Figura	Ref.	Medidas	Original	Aplicaciones
	E104	6,4 * 6,4 * 20	1607014101	Atomillador 1430 Cizalla 1502 Punzonadora 1527 Taladro 1101-1101E-1102-1170-1174UB2/75
	E112 E1112	6,3 * 16 * 22,5	1607014103 1607014108 1607014111	Fresadora 1611-GOF1600-GOF1700 Pulidora 1321-1324-1339 Martillo 11304-USH27 Radial angular 0304-0305-1321-1322-23-24-25-26-31-32-35-39 Taladro 1130
	E115 E1115	6,3 * 10 * 17	1617014106	Martillo 11205-11211-11222-GSH4(1307)UBH4.26
	E123 E1123	6,3 * 12,5 * 22	1607014106 1607014125 3607014000 3607014012	Atomillador GDS24-GDS30 Cizalla 1508-GSC4.5 Lijadora 300 Martillo 1557-0700 Pulidora GPO12E Radial angular 0300-0301-0302 Radial recta 1207-1208-1300-1301-1302-GGS6S Sierra circular 1557-PKS65 (3234.4) Taladro GBM6.2RE16.2RE-23.2-GBM23.2E-GSB90.2E
	E107 E1107	6,4 * 12,5 * 19	1617014110 1607014102	Martillo 11209-14-11302-05-GBH7/45-8DCE-8/65-USHUBH Atomillador 1431 Pulidora 1300-1301 Radial angular 1300-1301-1310-1311-1312-1313-14-17-18-20 Radial recta 1201-1202 Sierra circular 1550 Taladro 1103-UB2/77
	E124 E1124	6,3 * 10 * 21,5	1607014122 1607014126 1607014107	Cizalla 1507-GSC3.5 Martillo 1557.0 Punzonadora 1531-09-GNA2.5 Radial 1328-1329-1330-1336 Radial recta 1209-GGS16 Sierra circular 1557-1632 Sierra sable GSA900PE Taladro 1119-1119.1-1119.6-7-1120-1121-1174-GBM13-23
	E119 E1119	6,3 * 16 * 22,5	1607014130 1607014154	Radial 1351-1353-56-57-59-61-62-GWS19-19.180-GWS19.230 GWS21-GWS21-180-230-GWS24.180-230-300-PWS GWS23-180-GWS23-230 Ranuradora GNF65A-GSF65A-GSF100A
	E1128	6,3 * 16 * 23,5	1607014130	Radial GWS18.230-GWS20.230-GWS23.230
	E1153	6,3 * 16 * 26 FH6,3	1617014126	Martillo GBH10-GBH10DC-GSH10C Sierra de calar GSG300
	E199.23	7 * 8 * 18,5 FH4,8	1617014142	Martillo perforador GBH36















Figura	Ref.	Medidas	Original	Aplicaciones
	E108	5 * 4,5 * 13/15	2604320905	Atornillador 1401-1433 Cizalla 1500-1506-GSC1.6 Fresadora POF600ACE Punzonadora 1526-1529 Radial angular 1316 Radial recta 1203 Sierra de calar E1529-1575 Taladro GWB10-1119-1116-1132
	E111 E1111	6 * 14 * 23	1607014100	Cizalla 1501 Pulidora 1308-1309 Radial angular 1302-1303-1304-1305-1306-1307-1308-1309
	E114 E1114	5 * 8 * 18	1607014116 1607014131	Fresadora 1612.7-POF500/600-GUF4/22A-GUF22A Lijadora GEX150ACE Punzonadora GNA1-6L-GNA3.2-GUF4.22 Radial angular PWS5-115-550-7110-115-125E-125ES-PWS710 Radial Mini 1337-43-44-45-47-48-GWS7 100-115 GWS7 125 GWS7 125S-79 125C-CE-CES-GWS9 150C-CS
	E167 E1167	5 * 8 * 15,5 FH28	1607014144 1607014145	Radial angular GWS650 Radial Mini GWS6 100-GWS6.115-GWS6.115E
	E116 E1116	6,3 * 6,3 * 11,5	1617014112 1617014118	Martillo 11207-UBH3/20SE Martillo UBH3/16UBH3/24SE
	E118	5 * 8 * 16	2604320910	Radial recta GGS7C-GGS27C
	E160	5 * 8 * 9	2607014004	Taladro GBM1-GBM1E-GBM1RE
	E130	6,3 * 8 * 14	1609200634 1609202417	Cepillo P300-P400 Lijadora banda 0550-0552-0590 Sierra 1591.0-1560-61-62
	E131	6,4 * 10 * 19	1609200929	Lijadora banda 1270
	E178	6,3 * 14,2 * 17	2610908678 3607014505	Lijadora banda GBS100A-GBS100AE Sierra circular 1654-GKS55S-GKS65S-GKS75S-GKS85S
	E199.24	7 * 17 * 17 1609203L83	1609203J13	Ingletadora CCM8-10-12
	E132	8 * 10 * 22	1609201459 1609201460	Sierra circular 1563.0-1564.0-1565.0-1566.0 Sierra circular 1563-1564-1565-1566
	E133	6,4 * 8 * 29	1609201664	Aspirador GAS900RF-GAS1000RF





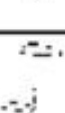

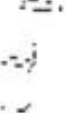









Figura	Ref.	Medidas	Original	Aplicaciones
	E134	6,3 * 10 * 21	1609243000	Cepillo 1590-1590.1 Sierra circular 1551-1552-1553-1556
	E136 E1136	6,3 * 10 * 17	1617014108	Martillo 11206-11208-11306-UBH6/35-UBH6/35D-USH6
	E140 E1140	6,3 * 12,5 * 22	1607014129 1607014143 1617014122 3604321012 3604321513	Fresadora GOF900A-GOF900ACE Martillo GBH5DCE-GBH5/40DCE-GBH38-GSH4-GSH5CE Martillo 11214.6-11216.7 Sierra cadena AKE30B-AKE35B-AKE40B-GKE35BC-GKE Sierra circular GKS54-55-65-65CE-66CE-68B-PKS54-PKS66
	E1156	5 * 10 * 17	1617014124	Martillo UBH4/26DS-GBH4DSC-GBH4DFE
	E161	6,3 * 12,5 * 22 FH4,8	1607014133	Sierra circular GKS54CE-PKS54CE
	E184	6,3 * 12,5 * 19	3604321514	Fresadora GOF1200A-GOF1300ACE Sierra GSA1100PE
	E1199.10	6,3 * 12,5 * 25 FH4,8	1617014138	Martillo GSH388-500
	E141	5 * 8 * 18	2604320908 2604320910 2604320912	Cizalla GSC2.8-1506.1 Lijadora POF500A- Punzonadora 1530.1-GNA2.0 Radial recta GGS27LC-1212-GGS7-GGS7C-GGS27C- Sierra de calar GST60PBE-1581-1582-1587-GST85
	E142	5 * 8 * 12,5 FH2,8	3607014001	Cizalla GSC16 Roedora GNA16
	E1129	5 * 10 * 16  FH2,8	1607014147 1607014151 1607014172	Cepillo GEB1000 Radial PWS13-125-PWS9-125- Sierra circular GKS55
	E1152	5 * 10 * 17	1607014138	Radial PWS9-125-PWS10-125-PWS13-125 Radial Mini 1380-81-GWS7-115-GWS7-125-GWS9-125-10-125
	E188	5 * 8 * 12,5 FH2,8	2604320911	Taladro GWB10RE-1132VSR-GBM10E
	E1146	5 * 10 * 17	1607014137 1607014138	Radial Mini GWS10-GWS14-GWS14-125-GWS14-159 Lijadora GBR14C
	E1168	5 * 10 * 17,5  FH2,8	1607014139	Radial mini GWS14-125

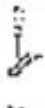

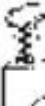

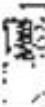
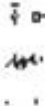





Figura	Ref.	Medidas	Original	Aplicaciones
	E340	5 * 8 * 14	2604321925	Cortasetos AHS400-24 Sierra de calar GST65-PST550
	E148	5 * 8 * 15	1617014117 2604321911	Martillo PBH1R-PBH200RE-UBH2/20SE(121.6) Roedora GNA16-GSC16
	E186	5 * 8 * 15,5	2604321915 2607014005	Cortasetos AHS36-AHS40-AHS45-AHS48-AHS55 Taladro GBM350RE
	E155	5 * 8 * 19 FH2,8	1617014127 1617014134	Martillo GAH500DSE-GBH2S-2SE-2SR-2.20S-2.20SE-2.24
	E161	6,3 * 12,5 * 22 FH4,8	1607014133	Sierra circular GKS54CE-PKS54CE
	E199.25	5 * 8 * 11	2609199048	Atomillador GDR9,6-12-14,4-18V-GDS12-14,4V
	E174	7 * 8 * 17 FH4,8	1617014131	Martillo GBH24VRE 1.7AH-GBH24VRE 2.5AH-GBH24VRE
	E142	5 * 8 * 12,5 FH2,8	3607014001 Roedora GNA16	Cizalla GSC16
	E138	6 * 7,5 * 9	2607034900 2607014901	Atomillador taladro GSB12VE-2-GSR18VE-2
	E199.01	5 * 8 * 19	1617000525	Martillo GBH2-22-26 Taladro GSB20-2
	E1120	6,3 * 12,5 * 25 FBFH4,8	1617014135	Martillo GBH5-7-E26
	E1199.02	5 * 10 * 23 FB4,8	1617014137	Martillo GBH3-28-GSH3
	E1199.03	5 * 8 * 17,5 FM2,8	1617014162	Radial PWS600-PWS6-115-PWS7-115-PWS8-125-PWS9-125
	E199.04	5 * 8 * 15,5 FM2,8	1607000352 1607000994	Radial PWS8,125-PWS9-125
	E199.06	5 * 10 * 21 FH2,8	2604321927	Taladro GSB2000-GSB22-2-PSB1000-2-PSB850





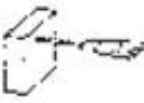

## Casals

Figura	Ref.	Medidas	Original	Aplicaciones
	E400	6 * 6 * 12	10090	Taladro 2T8-T10-3T10E-3T10P-3T10/2-3T10/2P-3T13/2-3T13
	E401	6,4 * 6,4 * 15	13050	Fresadora FC14 Lijadora orbital LN216-LN225 Martillo PE20-20E-P20/2RE Taladro TC6-8-10-10/2-13/2-00-TP12-TH10-PH10/2-13/2 TD13/4E-PC16-PC16E-PC16/2-PC16/4E
	E104	6,4 * 6,4 * 20	13010	Taladro 2T13-T16-T16/2-T19/2-T23/2-TP35/2-PC35/2
	E112 E1112	6,3 * 16 * 22,5	13410	Pulidora PL175-PR175 Radial DL178 Rozadora RC140 Taladro T26/4-T32/4-T32/2R-13410
	E1423	6,3 * 16 * 22,5  FH48	13413	Radial BDH20/230-DN20-DN24-VD20/230-VD20/230L
	E404	4 * 8 * 15		Radial mini DC115
	E422	5,5 * 8 * 15		Radial mini D115
	E405	5 * 8 * 15	13442	Cepillo BCE582-BCE682 Cizalla C25 Lijadora orbital BL160A-BLR170-BLR170M-BLR250 Radial BDH5/115 Radial recta MR25 Radial mini DM115-DC125-DB115/125-DH100-DN7-VD6/115 Roedora R20 Sierra de calar CA60-CA60P-CA60PEM-CA60PE-BCA50 BCA56/2M-BCA56E-BCA59P-BCA59PE VC61-VC61/2-VC61/2M-VC61E-M-VC65PE
	E1424	5 * 10 * 14,5  FH28		Cepillo VCE682-VCE782-VCE782M Fresadora VF750-VF1000E Radial BG10/115 Radial mini DN9-DN13-VG8/115-115M-125-VG10/115-115M Sierra circular BSC150-VSC50-VSC70 Taladro VT514RE-524RE-REA-VT624RE-REA-VT654RE VT1000/2REAT



## Casals

Figura	Ref.	Medidas	Original	Aplicaciones
	E406	6,3 * 8 * 15,5	10150	Lijadora-Pulidora LP200 Radial mini M115
	E418	6 * 6 * 15		Taladro 40U10
	E420	6 * 12 * 18		Taladro 39U15
	E407	6,3 * 8 * 14,5	13210	Cepillo CE75-CE83 Pulidora PR170-FV175 Sierra circular SC180-SC200-SC230
	E408	5 * 5 * 10,5	13490	Radial recta M25 Radial mini DL115
	E413	6,3 * 12,5 * 21,5	10460	Radial D178
	E419	6 * 16 * 24	10060	Taladro T23
	E421	6,4 * 6,4 * 15	13000	Lijadora delta BLD180-VLD230 Lijadora orbital VLR180A-VLR210-VLR210M-VLR300 Taladro C500P-C500.2P-PH550/2-VT500-VT502-VT510-VT512
	E425	5 * 8 * 15	130069073	Radial Mini AG10 Taladro VT622
		FM28		











## Dewalt

Figura	Ref.	Medidas	Original	Aplicaciones
	E879 E1879	6,3 * 12,5 * 24	940160-00	Radial DW882
		FHB4,8		
	E230	6 * 8 * 16,5	401853-00 401852-00 914633	Sierra circular DW62 Taladro DW505KS
	E913	6,4 * 10 * 17,5	247405-00	Cepillo DW625EK Injetadora DW700 Sierra circular DW351-DW365





Figura	Ref.	Medidas	Original	Aplicaciones
	E912	5 * 8 * 16	248447-01 247533-01 326525-00	Cepillo DW620-DW621K Lijadora DW431
	E933	4 * 6,4 * 10,5	401057-02	Fresadora DW685K
	E225	6 * 8 * 18	403522-00 588142-00 916368	Martillo DW563KC Taladro DW241
	E1942	6 * 10 * 24	356961-01 327148-01	Martillo DW540K-DW541K-DW543K-DW545K
		FHB4,8		
	E941	6 * 8 * 18	323660-01	Martillo DW566K-DW567K
	E1940	5 * 8 * 17	323660-4-8 323669-5-9	Taladros y Martillos Taladros y Martillos
	E935	6,4 * 10 * 17,5	131215-01	Fresadora DW650-DW650E
	E231	7 * 7 * 17	623919-00	Sierra DW702-703-713
	E934	6 * 7 * 13	445861-10 445861-05	Fresadora DW682K Lijadora DW411-DW423
		FM2,8		
	E220 E1220	6,3 * 12,5 * 23,5	940160-03	Radial DW49K-DW383-DW476-DW476QS-DW479-DW492 DW840QS-DW841QS
	E221 E1221	6,3 * 16 * 23		Radial DW490 Tiranzadora DW875
	E1999.03	6,3 * 16 * 26	487340-00 585041-00	Radial D28400-401-410-411-413-414
	E1999.04	6 * 10 * 24 FHB4,8	487131-00	Martillo D25404-405-568-570
	E1895	7 * 12 * 22	560323-07	Martillo DW558K

**Dewalt**







Figura	Ref.	Medidas	Original	Aplicaciones
	E886	7 * 10,5 * 17	450374-06	Radial DW849 Sierra DW306K
	E966	6,5 * 12,9 * 19	145323-02	Ingletadora DW704-DW705-DW708 Sierra DW65
	E222 E1222	6,3 * 8 * 13,5	930151 939539-01 930897-00	Radial DW401-DW448-DW450K-DW451K-DW806-DW811 DW816-DW818 Sierra DW321K-DW322K-DW323K-DW324K Taladro DW133
	E966	6,3 * 6,3 * 13 FH28	949833-04	Radial mini DW512
	E888 E1898	6,3 * 10 * 14	949647-02	Radial DW458-DW824 Sierra DW825-DW826
	E948	6,3 * 8 * 13,5 FH28	401852-01 401853-01	Martillo DW563K Taladro DW505KS
	E1660	6,3 * 14 * 20	402874-05 402874-07	Radial DW840-841 Lijadora de banda DW630-632
	E1936	6,4 * 10 * 14	949646-02 949646-01	Radial DW825-826-DW456-458-823-825
	E1965	6,3 * 10 * 20 FH48	402874-01	Radial DW830
	E889	6,3 * 8 * 13 FHB28	176949-00	Atomillador DW263K-DW268K-DW274K Taladro DW217-DW221-DW226-DW236-DW246
	E242	6 * 7 * 13	832998-07	Sierra DW320K
	E967	6,3 * 6,3 * 11,5	931235-00	Taladro DW203









Figura	Ref.	Medidas	Original	Aplicaciones
	E1945	5,2 * 9,5 * 12,7 FH28	585475-00	Martillo D25101-25102-25103-25104-25201-25203
	E1999.02	5,2 * 9,5 * 18 FH28	584429-00	Martillo D25303-25304-25330
	E1999.06	6,4 * 10 * 15	636128-03	Radial D28132-D28135-D28136-D28137-D28141
	E1999.07	6,4 * 10 * 13 FH28	636639-03 640491-03	Radial D28111-D28113-D28116-D28117-D28130 D28132-D28133-D28134-D28139
	E232	6,5 * 12 * 24	932497-00	Taladro BM51-53-DW153-153-P1721-23-23-24-RB130
	E1229	6,3 * 12,5 * 21,5 FH48	381028-02	Sierra circular D23700-D27112-DW702-703-706-8-12-16-17-18
	E1233	6,3 * 16 * 23 FHB6,3	1005550-02	Martillo D25899-d25901-d25941-D25980
	E1234	6,3 * 16 * 20	1002581-00	Taladro D21580-D21582-D21583-D21585





















Figura	Ref.	Medidas	Original	Aplicaciones
	E912	5 * 8 * 16	326525-00 247533-01 248447-01	Cepillo MFF8-MFF80 Fresadora MOF69-MOF96 Lijadora de banda MH158-MHB158 Lijadora orbital MVS94-VS71
	E933	4 * 6,4 * 10,5	940.940	Fresadora DS140
	E913	6,4 * 10 * 17,5	94.014.600 94.705.900	Cepillo MFF40 Injetadora PS174 Sierra MH151 Sierra MH165
	E934	6 * 7 * 13 FM28	445.861-12	Fresadora MBR100
	E935	6,4 * 10 * 17,5	131215-00 131215-01	Lijadora MBH90-MBH90E
	E221 E1221	6,3 * 16 * 23	933372-00 933373-00	Radial WS51E-WS52E-WS53-WS53E-54E-WS55E-WS56E-WS61
	E220 E1220	6,3 * 12,5 * 23,5 FHB48	933371-00 940160-03	Radial EAG204-216 Taladro DIAMANT2A-6A
	E967	6,35 * 6,35 * 11	931.235	Taladro BM11E

Figura	Ref.	Medidas	Original	Aplicaciones
	E1895	7 * 12 * 22		Martillo SH60K
	E1940	5 * 8 * 17	323.660.05 323.660.09	Taladro SB21EK-SB43EK
	E941	6 * 8 * 18 FH2,8	323.660.01	Martillo MBH24RLM-MBH26RLM
	E1942	6 * 10 * 24 FH4,8	326.961.00	Martillo BH45EL-BH46EK
	E222 E1222	6,3 * 8 * 13,5	939.539.01	Radial WS11-WS12-WS12E-WS13-WS14E
	E966	6,3 * 6,3 * 13 FH2,8	949833-04	Taladro SB15EA
	E896	7 * 10,5 * 17	450374-06	Sierrasable MSS810
	E956	6,5 * 12,9 * 19	145323-02	Sierra EMS705-PS374-MH265
	E225	6 * 8 * 18	403522-00 588142-00 916368	Taladro BM19-SB13
	E898 E1898	6,3 * 10 * 14 FH2,8	949647-02	Radial WS42
	E1936	6,4 * 10 * 14	949646-01 949646-02	Radial WS31-32-41
	E1965	6,3 * 10 * 20 FH4,8	402874-01	Radial WS45A
	E899	6,3 * 8 * 13 FH2,8	176949-00	Atomillador BM12-14-15-17-18 Taladro BS10-20-25

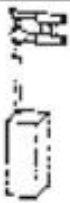

## Farco

Figura	Ref.	Medidas	Original	Aplicaciones
	E1605	6,3 * 12,5 * 23		Radial DS217
	E607	6,3 * 6,3 * 17		Pulidora angular LP241
	E407	6,3 * 8 * 14,5		Pulidora angular LP804
	E405	5 * 8 * 15 FH28		Radial mini AM451/651
	E408	5 * 5 * 10,5		Radial AM/AMR421 Taladro TL/TL402
	E112 E1112	6,3 * 16 * 22,5		Radial AM1676/78N-AM1806/8-AM2066/8
	E1611	6 * 12,5 * 20		Radial 1608
	E104	6,4 * 6,4 * 20		Taladro TLP632







## Fein

Figura	Ref.	Medidas	Original	Aplicaciones
	E736 E1736	8 * 12,5 * 22 FHB4,8	30711098009	Radial MSF666
	E1986	8 * 12,5 * 23 FHB6,3	30711137006	Radial WSB25/230-WSG20/230
	E745 E1745	6,4 * 12,5 * 18	30711056001 30711061008	Radial MSF679D
	E913	6,4 * 10 * 17,5	30711103000	
	E1999.15	5 * 8 * 13,5 FH28	30711146001	Supercut FSC1.6-FSC2.0



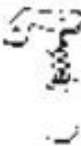

## Fein







Figura	Ref.	Medidas	Original	Aplicaciones
	E915	4 * 5 * 8	30711066000	Atomillador ASSD715
	E977	5 * 6,4 * 13	30711062001	Radial recta MSF636 Sierra de calar AST636
	E1916	6,4 * 12,5 * 18	30711085005	EZ11-85
	E960	5 * 6,4 * 16,9	30711059007	Taladro ASZ636-ASZK636-DS636-ASZ51-ASC51-ASB636
	E1961	6 * 8 * 14	30711084001	Radial MSF642
	E1988	5 * 10 * 17 FH48		Radial WSG12/125-WP012/27E
	E1999.12	5 * 8 * 14 FH28	30711128005 30711140000	Sierra calar ASTE638-Sierra Astixe638-639-FSN400-404
	E981	5 * 8 * 17	30711067004	Lijadora MSH648 Martillo FSC649 Radial recta MSF649 Radial recta MSF649 Taladro ASB6471-ASB648-DSC648
	E1799.05	5 * 10 * 17 FHB48	30711144004	Radial y Pulidora



## Felisatti

Figura	Ref.	Medidas	Original	Aplicaciones
	E709	6,3 * 12,5 * 20	6518165053	Ingeladora M79 Radial 200.6-200.8-TP190
	E925	6 * 6 * 12,5	5164316033	Radial TP613 Sierra circular SF251-SF509 Taladro SF206Q-SF208A-SF249
	E711	6 * 6 * 15		Lijadora FEL21-TP115
	E790	6 * 9 * 32	6948316043	Aspirador AS21



Figura	Ref.	Medidas	Original	Aplicaciones
	E718	6 * 12 redonda		Fresadora FEL1-FEL1P-FEL60
	E760	7 * 12 * 18		Pulidora CT272-CT252-CT511-CT248-CT285 Radial FEL22-FEL24-CT223-CT232 Sierra de calar CT176-CT178-CT253
	E918	4 * 5 * 8		Atomizador ASSD715
	E919	6 * 6 * 13	5323316020	Lijadora TP31-TP31C-TP517-TP602 Taladro TP600
	E201	6,3 * 6,3 * 13	5169316027	Lijadora TP501-TP502 Radial 116TV Sierra de calar TP258-TP258E Taladro TP601-TP602.1-TP602.2-TP602P-TP616
	E969	6,3 * 16 * 20		Radial A24.6-TP220-TP226-TP228
	E965	8 * 16 * 21 FH4,8		Radial AS20.6-AS20.8
	E970	6,3 * 6,3 * 14		Lijadora TP114
	E984	6,3 * 8 * 14 FH2,8	5421316036	Pulidora TP521 Radial TP100-TP114-TP116-TP125-TP126 Sierra de calar TP28-TP243-TP257
	E971	6 * 9 * 20	5214316016	Radial TP170 Radial mini TP176-TP513-TP515
	E972	6,4 * 16 * 20	5211316009	Radial TP220.6-TP220.8
	E649	6,3 * 12,5 * 16 FH4,8		MT216KS



## Festool

Figura	Ref.	Medidas	Original	Aplicaciones
	E603 E1603	6,3 * 7 * 15,4  FMB2,8	411707 K23	Lijador R01-WET Radial mini WS0402-WS0502-WS0506-WS0510 Sierra de calar PS1
	E951	6,3 * 8 * 16	482007 38	Lijadora vibr. FSMRTB-RTM-RS1-RS2-RS3-RS4 Sierra circular AXF45-AXT50-AXT55
	E952	5 * 8 * 17	410280 Z86	Lijadora ATT52 Lijadora vibr. RTT
	E953	6,3 * 12,5 * 16	483766	Sierra circular AXP65-AXP85
	E1954	5 * 7 * 12,5  FHB2,8		Lijadora rotorbital WET2E
	E1958	5 * 8,5 * 12,5  FH2,8		Lijadora









## Flex

Figura	Ref.	Medidas	Original	Aplicaciones
	E1600	6 * 13 * 25	K13	Radial DL9-DL9S-ZL9
	E601	6 * 16 * 20	K21	Cizalla K2750C-K2765C Radial ZL2108-ZL2708-L2104C-L2106C-L2108C-L2806C Taladro L2402-L2600-LW2402-LW2602
	E602 E1602	6 * 9 * 22	K9	Radial mini DL9
	E1604	5 * 8 * 20	K8	Radial DH1202-ZL1402-ZL404
	E614	8 * 16 * 19,5	K22	Radial ZL2108-ZL2708
	E615	10 * 12,5 * 20	K34	Radial ZL2108
	E754	6 * 13 * 19	K20	Radial angular ZH1206-ZL1208 Radial recta H1206-H121 Taladro BSS1202VR



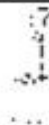









## > Flex

Figura	Ref.	Medidas	Original	Aplicaciones
	E603 E1603	6,3 * 7 * 15,4	K23 K33	Cizalla K120VE-P120 Fresadora F150YFR Lijadora BV1506-LP1503VR Radial angular ZL1109-ZL209S-ZL109-L107W-L110Y-LG150 Radial recta F427MH105MH127LM Ranuradora M1506FR Sierra de calar SLO3UE Sierra circular S110VE Taladro BSS150MR-CB1506VR-LW1503-XC1506VR
	E613	6,3 * 8 * 15 FMB2,8	K44 K47	Pulidora L1509 Rozadora MSF130
	E628	6,3 * 7 * 15,5 FHB2,8		Radial H127LM
	E1629	6,3 * 7 * 15,5 FH2,8	K56	Radial H127M
	E775 E1775	6,3 * 8 * 19 IM	K30 K32	Mezclador R600UE-RZ600UE Pulidora CK603UE-CK603UR-L1503 Radial ZLK604-ZLK610-ZSK602E-LK6010-LK604 Sierra circular SR602VR-SRA602VR-SRP602 Taladro LW603VR
	E776	6,3 * 16 * 22 IM	K29	Radial ZLK2006A-ZLK2008-LK2004C-LK2006C-LK2008C
	E638 E1638	6,3 * 8 * 15 FH2,8	K49	Radial LG1707FR
	E1645	6,3 * 8 * 15 FM2,8	K70	Mini Radial L1309FR-VR-L3410FR-VR-L3403FR-VR-L3309FR

## > Hilti

Figura	Ref.	Medidas	Original	Aplicaciones
	E1622	7 * 12,5 * 26		Martillo TE74-TE75-TE76-TE704-TE705-TE905-DD100
	E1623	6,3 * 10 * 19 FH4,8	79594	Martillo TE14-TE15-TE24-TE54-TE55-T104-TE504





## > Hilti

Figura	Ref.	Medidas	Original	Aplicaciones
	E1786	6 * 8 * 14	80594	Martillo TS824
	E1772	6,3 * 12,5 * 19		Martillo TE72
	E774 E1774	6,3 * 8 * 25		Martillo TE42
	E1791	6,3 * 8 * 18,5 FH2,8		Martillo TE12-TP90
	E1792	6,3 * 12,5 * 19		Martillo TE92-TP800-TP804
	E1646	6,3 * 12,5 * 26 FHB4,8		Martillo TE804-TE805-TP600
	E1793	5 * 8 * 12	75561/1	Martillo TE5-T8-T10-TE10
	E1640	5 * 8 * 15	240612	Atomizador ST18
	E1641	6,3 * 16 * 22 FH6,3-FM6,3	208226	Maquina de taladrar DD160E
	E1794	6,3 * 10 * 26 FH2,8		Martillo TE52-TP400
	E1642	5 * 8,5 * 18 FH2,8		Martillo TE2-TE2M-TE29
	E1799.03	7 * 12,5 * 26 FHB4,8	366124	Martillo TE56
	E1609	6,3 * 10 * 19 FH2,8	76594	Martillo TE25

## > Hitachi

Figura	Ref.	Medidas	Original	Aplicaciones
	E1699	7 * 17 * 23 FH6,3	999061 999089	Radial G23SC2-G23SF2









Figura	Ref.	Medidas	Original	Aplicaciones
	E796 E1796	7 * 17 * 17	937943 974611 999044 999074 999077 999081	Cepillo eléctrico P12R/A/P100F/PDH180C-PH65A-PS15A Fresadora M12SA/V Injetadora C12FA Martillo H65SA-90SA-BM25-H65SB-H90SB-H90SC Radial G18SE2/SG/SH/SF/U/UA/UB-G23SC-GS23
	E798 E1798	6,5 * 7,5 * 12	999041 999072 999080	Aspirador UNDH4 Atomillador W6V1-W6V2-W6VA-W6VA1-VA2-VAZ-W6VB Cepillo eléctrico P20SA-P20V Cortasetos F445-FCH66-FC5SAM-FC5SA1-FCJ55-FDV12T Fresadora FMB Lijadora orbital FS10SA/BFSV12LUH7-SV8SA-SV12SA Martillo DH22VB-DMT13A-DU10SHSN6-DH18VB-DH22VD Pulidora SV12SA/SD/SE-SV12V Taladro D6SH-DW15Y-DSV8-DV14-DV20V-D10VC-DV20V
	E921 E1921	6,5 * 7,5 * 13	999021 999070 999084	Atomillador W4YE-W4YF-WH12-WH14-WH16 Cepillo eléctrico F20A-PDA100D-P20SB Cizalla CB10VA-CE16-CN16 Fresadora TR6/A/1A/PLUS-M6SA/SB Lijadora orbital LDV4-SV12-VR16/VRV16-SAY150A Martillo DH20V/22V/22VA/25V Pulidora S0110/S0D110-SP13 Radial GP2-GP2SA Radial mini CP2-CP12B/S1/SA/YB1-FG12SA2-G1001/SB1/SF Sierra de calar CJ60/60V/60T-CJ65/65S/65V/65VA/65VB Soplador PB20 Taladro D10YA
	E922 E1922	7 * 11 * 17	961612 999043 999056 999073	Aspirador NUPSR3-NUSR-NUSR5 Atomillador impacto WH22 Cepillo eléctrico F30A/AT-P30-PDH125-PH40-PR25B/38E Fresadora M8-M8V-TR8 Injetadora C8FA-C8FB-C8FC-C8FS Lijadora banda S15-SB8T-SB10T-SB10V/75-SP18/18T/18V Martillo BM25Y-BM50/50SA-BUPN3-DH28Y-DH38YA/YB/YF Pulidora SAT180-SAT182 Radial mini G13SC-G15SA Sierra sable CR10V-CR12V-CR17Y Sierra circular C6/6U-C7/TU/TSC/T5C/T5D-CB10V/12V/17Y Taladro D13-D13SA-D13Y-DC120V-VR38-VTP16A-VTV16
	E923 E1923	7 * 13 * 17	961946 999036 999038 999071	Cepillo eléctrico P20SD-P40-P50-P50K-P50SA-PG21SA Cizalla CN45SA Fresadora M12SB-TR12 Lijadora banda SB110 Martillo BLU4-DH50SA-DH50SA1-DH50SB-DH55-DUPN2 Pulidora SAH180-SR15 Radial G18DF-G18SC-G18SD-G23SA-SB-GP13 Roedora CN60SA Sierra de cadena C6SA-C7BD-C7SB-C10FB-C75B-C12-13 Sierra circular C8-C8U-C8V-C9U-PSM7 Tronzadora HU12-HU14



## > Hitachi

Figura	Ref.	Medidas	Original	Aplicaciones
	E1928	6,5 * 7,5 * 14 FH28	999046	Sierra calar CJ65S2-CJ65VA2-CJ65V2
	E930 E1930	6,5 * 9 * 17	999076 999088	Radial mini G12SE-G13SE-G13YC-G15YC
	E1799.06	6,5 * 9 * 13,5 FH28	999090	Radial y Taladros
	E799.01	5 * 6 * 11	999054	Atornillador DV14-WH12-WH14-WH8-9-WR12-14-8

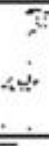
## > Kango

Figura	Ref.	Medidas	Original	Aplicaciones
	E414	5 * 10 * 16		Martillo 400-500-501
	E415	5 * 10 * 18		Martillo 627-628
	E417 E1417	6,3 * 9,5 * 20		Martillo 900-950-900X-950X
	E416	5 * 10 * 15		Martillo 637-638
	E448	6,3 * 9,5 * 21		Martillo 900KV-900MV-950KV
	E1455	6,3 * 9,5 * 20		Martillo 900-950-900X-950X
	E449	6,3 * 6,3 * 17		Martillo 422-426
	E450	6,3 * 20 * 25	9170055492	Martillo 2500
	E451	6,4 * 12,8 * 18,5		Martillo 1400 (1ª versión)

## > kango

Figura	Ref.	Medidas	Original	Aplicaciones
	E452	6,3 * 16 * 24	9170305422	Martillo 1400 (2ª versión)
	E453	6,3 * 8 * 18 FHB4,8		Martillo 430C-522-526
	E1456	8 * 14 * 19,5	4931375556	Martillo 900K

## > Kress

Figura	Ref.	Medidas	Original	Aplicaciones
	E780	5 * 6 * 12	95669/8	EHS121150ES
	E596	6 * 9 * 32	29945	Aspirador NTS1100EA
	E781	5,5 * 8,5 * 18 FH2,8	95670/6	Sierra circular CLKS 6050-6055
	E783	6 * 8 * 13 FH2,8	24089	Radial mini WS6350-600WS-800WS-520P
	E1782	6,3 * 12,5 * 20 FH4,8	29357	Sierra circular CLKS 6060-1600KS-1400KS
	E784	6 * 8 * 14,5	30565	Taladro SB2210-CST6270-CRS6170-720FH-200RS-420SM/450
	E785 E1785	6,4 * 12,5 * 19	95673/0	Radial WTS6350R
	E1786	6 * 8 * 14	18467 16638	Fresadora OF6901 Martillo EH6701 Radial mini WS6701 Taladro SBLR4213/8614-600/800-SM-380/520-BM-450ES
	E1594	7 * 11 * 17,5	33550	Martillo 1150PSK Max
	E598	6 * 8 * 14,5	19631	Martillo 240APBE

## > Kress

Figura	Ref.	Medidas	Original	Aplicaciones
	E788 E1788	6,4 * 16 * 25	95674/8 33471	Radial WTS6361-6360-6380-6381
	E593	5 * 8 * 12,3	46989 46995	Atornillador 450TBS-455TBS Taladro 420BS-450BS-420BME
	E595	5 * 8 * 14	31535 47280	Martillo 240PAH-APH240
	E599	5 * 8 * 14,5  FH2,8	24837	Taladro SBLR2250-2255-2360-2362-2475-2480 Martillo PH500-HME18-20-HMx24-PSE500-PSX550-600-750 Radial WS6368-6375-6380-6390 Fresadora OF6990-E750DF
	E1119	6,3 * 16 * 22 FH6,3	26791	Radial WS6372-6382

## > Legna

Figura	Ref.	Medidas	Original	Aplicaciones
	E700	6 * 12 * 16	6069	Cepillo R52 Lijadora U170-V690 Sierra circular SC681
	E701	5 * 10 * 19		Cepillo
	E702	6 * 10 * 19,5	4029	Ingletadora SR250 Lijadora orbital L0794-L0683-C173-OBS69
	E703	5 * 6,4 * 14	49022	Cepillo G82-R81 Fresadora R800
	E704	5 * 5 * 15	44021	Lijadora orbital L0182
	E731	5 * 5 * 15	1054	Lijadora FU3-FU4





Figura	Ref.	Medidas	Original	Aplicaciones
	E1840	6 * 10 * 15	CB100 CB101 CB102 CB103 CB105	Cepillo 1001-1100-1125-1600 Cizalla JS3200 Desbastadora NPC1100-PC1100 Injeteradora LS0810 Lijadora 9297SPC-9045B-9045N-9218PB-9218PBL-9741 Lijadora-pulidora 9207SPB-9207SPC-9217SPC-9218SB Llave impacto 6906 Martillo HK1800-HK1800LHK1810-HM0810-HM0810B-0821 Radial 9900-9900B-9901-9924DB Radial mini 9005B-9006B-GA5000
	E848 E1848	6,5 * 13,5 * 16	CB152 CB153 CB154 CB155 CB161	Cepillo 1804N-1805B-1805N-1806B-2012-2030-2030N-2040- Fresadora 3600B-3600BR-3601B-3604-3612BR-3600-3600H Injeteradora LS1013-LS1030-LS1440-LS1510-LS1011-LS1020 Lijadora banda 9401-9402-9041 Martillo 3800NA-HM1200-HM1200B-HM1200K-HM1201 Radial 9607HB-9607HBS-9609HB-9609HBS-9609NB-9609NG Taladro 8900N-5100DR-5103-5201-5401-5402-5500S-5700-5800
	E857	5 * 8 * 12	CB50 CB51 CB115	Cepillo 1901-1902-1923B-N1923B-1900B-1923H Fresadora 3700-3700B-3702B-4401 Lijadora banda 9030 Sierra calar 4300BA-4300BV-4301BV Taladro 6013B-6013BR-6300-8419B-MM32/2-6016-6300LR-NB
	E914 E1914	7 * 18 * 16	CB203 CB204	Fresadora 3612-3612C Martillo HM1303-HM1303B-HM1500-HM1500B-HM1800 Radial 9027-9027F/S/SF-9029/F/SF-9037F/SF-9039-9069 Tronzadora 2414B
	E832	5 * 8 * 9,5	CB52	Cizalla JS1600-JS1660-JS1670 Fresadora 3705 Lijadora orbital 9035KB Llave de impacto 6905B
	E839	3,8 * 5,8 * 12	CB414	Tijeras 4603DW
	E653	4,9 * 5,3 * 8,5/9,5	CB424	Atomillador 6916DWA-6918DWA Taladro 6214DWA-6503DVDE
	E654	7 * 10,5 * 10,9	CB429 CB432	Injeteradora BLS820S Sierra 4334-5621-JR140
	E655	7 * 7,4 * 9,5	CB430	Taladro BHR200S-DWAE6203-6207 Sierra BSR730SH
	E656	5 * 6 * 11,5	CB431 CB434	Atomillador 6916D-6916DWE-6990 DWAE















Figura	Ref.	Medidas	Original	Aplicaciones
	E851	5 * 8 * 11	CB56 CB57 CB64	Atomillador 6800DBV Lijadora 9035-9035N Lijadora orbital B04510 Radial recta 906-GV6000 Sierra calar 4301SB Taladro 6010BVA-6500R-6510PBL
	E855 E1855	6 * 10 * 15	CB106 CB113 CB117 CB166	Cepillo 1125-1911B Fresadora 3620-3606 Martillo HR2000-2010-2010N-JR3608 Sierra calar 4302C Sierra sable JR3010 Taladro 8406-8420v Taladro percusión HP2020-2000-HP2010N-HP2404-3608B
	E1831	5 * 11 * 12	CB302	Radial mini 9541-9542
	E834	5 * 8 * 12	CB55	Atomillador 6801B Cortasetos UH4500-UH6300 Sierra sable JR3000V Taladro 6300T-6701B-8419B-2-8419SB
	E1875	5 * 11 * 16,5	CB303 CB304 CB327	Lijadora 9227CB Radial 9015B-9016B Sierra circular 5603R Martillo
	E849	7 * 11 * 19	CB251	Sierra circular 4101R-4101RW Sierra sable JR3020
	E850	5 * 8 * 11	CB69 CB70	Cortasetos UH3000 Lijadora 9036 Radial mini 9514BH Sierra de calar 4320 Taladro 6501-6501A
	E833	5 * 8 * 9,5	CB63	Lijadora 9035KB Roedora JG1600
	E1878	5 * 8 * 12	CB60	Taladro
	E1899.07	6,5 * 13,5 * 27	CB171	Martillo HR4501C-4511C-5201C-5211C



Figura	Ref.	Medidas	Original	Aplicaciones
	E853	5 * 8 * 11,5	CB65 CB72	Fresadora 3705 Radial angular 9035KB-9595B Radial mini 6501B-6501BH-6503BH-9501CB-9505BH Radial recta 906H
	E856	6 * 9 * 12	CB408 CB411	Atomillador 6830-6832 Fresadora 3703-3704-3901-4402 Lijadora banda 9031-9910-9911 Radial mini 9501BM-6505BM-9520B-9520NB-9521NB-9522NB
	E899.14	7 * 11 * 16,5	CB253	Radial GA5021C-GA6021C
	E1860	6 * 9 * 12,5	CB415 CB417	Atomillador 6620V Llave impacto 6904V-6904VH-6905H Martillo HR2400 Taladro 6402-NHP1300S
	E861	6 * 9 * 11	CB419	Atomillador 6821 Lijadora orbital 9046-B05000-B05001 Martillo HR2410 Radial mini 910-N910 Sierra calar N4304-N4305-4304-4304AT-4305-4305T Taladro 800-N800-6310-6408-6410 Taladro percutor HP1500-HP1501-HP2030-HP2031-HP2040 HP2041-HP2042
	E862	6 * 10 * 15	CB119	Cortasetos UH4510-UH6310
	E858	9 * 10 * 22 FHB28	CB403	Sierra cadena 5014-5016
	E1652	5 * 11 * 15,5 FH28	CB318	Lijadora B06040 Radial 9561-9562-9564-9565-9566-GD0800-0810 Pulidora PW5001
	E661	5 * 11 * 15,5 FHB28	CB325	Radial
	E1662	6,5 * 11 * 25 FHB28	CB350	Martillo

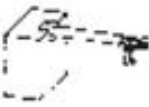
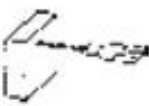

> **Metabo**



















Figura	Ref.	Medidas	Original	Aplicaciones
	E802 E1802	6 * 6 * 13	34301033 34301105 31603339	Lijadora banda SF282 Lijadora orbital SR220-225-3320-4320-4321-282-283-284-285 Sierra calar 4330/2-4330E-450-455 Taladro SBE450 R+LSBE460/2R+LSB450/2E450/2RL
	E1818	6,4 * 6,4 * 16	34301135 31603338 31603372	Cepillo eléctrico H0 0882
	E800 E1800	6,3 * 8 * 12	34301067	Atomillador SE6345/2R+L-6341-6342-6343-6344-6346 Radial EW7117QUICK-7116S-7127QUICK Radial mini EW7126S Taladro BE5000SR+LBE620/2SR+LB620/2S-SB600/2 SB620/4S-SB651/25R+LSB800/6S-SBEK680-E620 EK600/2-SB650/2RL Taladro percutor SB600/2S-SB600/4S-SB600/4SF-SB620/2S SB620/4S-SBE480/2SR+LSBE570 SB570/2SR+LSB600/2S-SB620/2S SBE650/2SR+LSBE651/2SR+L SBE700/2SR+LSBE701/2SR+L SBEK750/2S-SBEDV1015/25R+L SBE680/2S-SBE710/2SR+LSBEK680
	E1801	6,3 * 8 * 15	34301118	Atomillador 6341-6341R+L-6341R+L/B-6342R+L Lijadora BAD665-BAE0666 Martillo BHE6020SR+LBHE6026SR+LE1120S Sierra circular KS0852S Taladro B7532/4-2E680/2S-SBEK750/2-EDU800/2S-SBEDU100 SBE110/2S-4308B-4308eIB-4308eIC-4310/2B-4310/2eI R+L/A-4310eI/R+L/B-4310eI/R+L/C-7500 10SB 7500 10/2B-7500 10/2SB-7500 10/2SeIB-7500 10/2Se
	E1809	6,4 * 6,4 * 14,5	34301030 34301046 34301082	Cizalla KU6870-6870B-6872 Lijadora banda 6171-6171B Pulidora angular 6155/B-P6155/58 Radial mini 4315S-4316S-6139-6139A-6139C-6139F-6140-6140A 6140B-6140C-6140F-6160S-6161S-6161SA/SB- EW4316S-WS3315-WS3316 Sierra calar 561-EP563/64-65-66-6305-6305A-6310-6310B Taladro percutor SB505 R+LSBE500/2SR+LSB505-PB501
	E804 E1804	6,3 * 8 * 15	34301039 34301072 34301073 34301095	Cepillo H04382 Lijadora banda 3360-BAE0875-BA0775 Radial EW10.125 Quik Radial mini 6162KS/KSA-6162SA-EW9150S-EW7125S-EW812 EWE9150-EWE11125-EWE11125S-EWE11150
	E1805	6,3 * 12,5 * 18  FHB28	34301071	Aspirador ASR1263 Lijadora W14175-BA0876 Martillo BHE1129S Radial KS4345S-W14176-W20180X-W201801-2018X-20230/X Sierra circular 4345S-4346S-KS65-6323S-KS1155S-65S-1468S KS4345-KSE16685-1678S-1785S

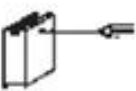

Figura	Ref.	Medidas	Original	Aplicaciones
	E1822	6 * 16 * 20 FHB6,3	34301158 34301177	Radial WS20230-2030-2080-2530
	E1811	8 * 14 * 18 FHB4,8		Amoladora 1806
	E1806	8 * 14 * 18	34301084	Martillo TR3300 Pulidora P14175-SN14125-W14175 Radial W16167-W1923-W1923X-W1980-W1980X-W2080 W16178-W16178X-W16230-W16230X-W19178-W19178X W19230-W19230X-W20180-W20180X-20187 Sierra circular KS1785S-KS4346S
	E1807	6,4 * 10 * 21	34301017	Martillo BH11130S-1131S Radial EWE1115S
	E1817	6,4 * 8 * 16	34301001	Lijadora BA6100
	E1808	8 * 14 * 19	34301063	Radial 2636S-2636SA-6127-6129-61065-610650-61068-610680 61167A-61167C-61169A-61169C-611760C-611670B 611670C-611690A/B/C-61265S/SB-61268S/SB-612650S 612650SB-61268S-61268SB-TR2636S
	E1810	6,3 * 6,3 * 14	34301107	Cizalla KU6873 Fresadora OF528-529-FM529 Radial P6155 Radial mini EW6114S-EW6124S-EW6115S-EW6125S-WS515 EWE6115S-F0520-GS6139-GS6140-GS6145 Radial recta GS6139-GS6140 Sierra calar STEP564-565-566
	E1814	5 * 6,3 * 15	34301093	Atomillador SE4450R+L-4420R+L-4430R+L-4431R+L Taladro B480S-481S-B504-BE504-B500S-CB502 Taladro percusión SBE380SR+L-SBE420/2SR+LH20/2S
	E1819	6,4 * 8 * 16 FHB2,8	34301113	Radial EW6114S-EW7115S-EW7117-EW7126S-EW7127 Quik EWE7116S-EWE9123S-EWE9125S-EWE9126S-9127
	E1813	6,3 * 8 * 15	34301102	Radial mini EW8125S Taladro B720/2S-BE720/2SR+L-B800/2S Taladro percutor SB720/2S-SB720/2SR+L-SBEDV800/2S

## > Metabo











Figura	Ref.	Medidas	Original	Aplicaciones
	E815 E1815	6 * 6 * 11,5	34301088	Atomillador SE4410R+L Lijadora orbital SR221-SR226-SR227 Sierra calar ST450-STE450-ST350-STE350-451/2-E452 Taladro B380SR+L-B350-BE350-BE460R+L
	E643	5 * 8 * 14,5		Taladro B250
	E823	5 * 8 * 14,5/17	34301123 31603367	Lijadora SXE450 Duo
	E775 E1775	6,3 * 8 * 19,5	34301119 31603365	Sierra sable PSE102-1027
	E1821	5 * 10 * 12,5	31603373	Taladro SB650-650/2S Cepillo HO E 0983
	E899.12	5 * 10 * 14,5	31603494 31604595	Atomillador DWSE6.3-Martillo KHE24-96-Sierra KS-Taladro
	E829	5 * 8 * 12	31603387	Taladro SB13-SBE560
	E1824	5 * 10 * 16	31603551 34301170	Radial mini W7-115
	E1899.13	5 * 10 * 16,5 FM2,8	31604163	Radial mini W8-115-W8-115 Quick
	E899.01	6 * 9 * 15,5	31603505	Lijadora
	E1899.03	6 * 12,5 * 19 FM2,8	31603507	Martillo y Radial
	E1825	6 * 16 * 22 FM6,3	34301177	Radial W2080-W2081X-W2030-2031X-2280-2281-2230-82

## > Perles







Figura	Ref.	Medidas	Original	Aplicaciones
	E708	5 * 8 * 12		Convertidor frecuencia
	E777	5 * 8 * 14		Atomillador HSW15 Radial mini HSW1111
	E900	4,9 * 6,5 * 13	775215	Taladro XB110/1100-XB210/2100-XS210/2100



## > Perles

Figura	Ref.	Medidas	Original	Aplicaciones
	E901	6*9*17	775201	Taladro HB160/1600-HB165-HB260/2600-1520-PSSB1530
	E902	6*9*14	775221	Taladro PSB270-2700-272-275
	E903	6*7*12,5	775208	Radial mini HSW109
	E904	6,4*10*15	775218	Radial mini HSW222-225
	E905	6,2*16*20 HB48	775213	Radial angular HSW356-356E-HSW358-358E
	E906	8*12,5*20	775153	Radial angular HSW56/6N-56/8N-596/E-598/E
	E907	6,4*12,5*22	775198	Lijadora UP704 Pulidora UP702/702W Radial F35F Tronzadora HSW716/728
	E910	4*7*15		Taladro PSB137
	E917	5,5*8,5*14 FH28		Radial mini HSW115
	E1968	6,3*10*20 FBH48	702835	

## > Protocol

Figura	Ref.	Medidas	Original	Aplicaciones
	E1570	6,3 * 16 * 22 FH48	627024	Radial
	E1571	5 * 10 * 17 FH28	627036	Radial
	E1572	5 * 8 * 16 FH28	627001 627007 627019 627040	Radial
	E1573	6,3 * 10 * 14	627002 627010 627034	Martillo, Taladro y Roedora
	E1575	5 * 8 * 12,5	627003 627005	Taladro
	E1578	6,3 * 10 * 11	627033	Radial
	E1574	6,3 * 16 * 22	627041	Radial
	E580	5 * 8 * 14 FH28	627011	Martillo

## > Rupes

Figura	Ref.	Medidas	Original	Aplicaciones
	E617	6 * 8 * 13 FH28		Lijadora BR51A-BR55-LH16 Radial mini BA215



## Rupes









Figura	Ref.	Medidas	Original	Aplicaciones
	E619 E1619	6 * 9 * 20		Lijadora de disco SM1-LDR23-LDR6-LT2-LAR3-LAR23-NL2-3 Radial LAR2-5-8-12
	E620	6 * 6 * 16		Atomillador TN13-TN13/2V-PC14/16E Lijadora LE7-LC7-TN6-8-10V-20V-10R-PC15-CS8-CN6R-CV8
	E705	8 * 14 * 35		Aspirador S130
	E710	6 * 7 * 12		Atomillador RE72-RE74-AR9-AR30 Lijadora SS20-BR9-BR8-CE6-CE6R-CA6
	E712	6 * 8 * 14		Lijadora SS70-PN30-PN30E-SSPF Taladro ND13-ND13R-ND16-ND13E
	E713	6 * 8 * 18,5		Lijadora orbital 133 Taladro TP13-TP13R-PC13-TP16-PC30
	E735	7 * 10 * 22		Pulidora SM10-SM14R1K
	E621	6,3 * 11,3 * 28,5		Aspirador S80
	E739	6 * 7 * 14		Lijadora orbital Taladro TR10-TR13-PD10-PD13-PD30-PL30-NL13
	E742	6 * 7 * 14		Lijadora BR3-BR5 Radial mini BA15
	E625	7 * 12 * 20		Radial GM62
	E639 E1639	6 * 9 * 20  FME28		Pulidora LH31-SM43





Figura	Ref.	Medidas	Original	Aplicaciones
	E648	7*18*19	1540185	RadialG231SG2320
	E706	5,2*11*15,5	61445409007	PulidoraG1500 SierracircularC100A
	E714	6,4*9,5*16,5	6540043 6540503/13	CepilloL22LN LijadoraNS6200ANS6300ASU6200A Lijadora bandaB7100BE424B422BE422 SierracircularW5502
	E715 E1715	6,5*16*16	639854160	CepilloL580 InjetadoraG1800G1855 RadialG1850PC3050NG2350R600
	E716	6,4*13,4*17	6540813 6541283 6540053/63	InjetadoraTSC306C3560C307NAC356NAC357C360 MartilloCH481ED381ED382ND SierracircularRA200NRA2500NW6402NCW8402NC
	E741	5*8*11	6541173 6540753 6540033 6540803	CepilloTR30L120N RadialSG1150G1150 SierracircularW55P TaladroPD1921PD1921V
	E756	7*16*18	6540603	RadialG2355G2325G1855 MartilloCH500
	E761 E1761	7*11*18	6540573 6541363	MartilloCH450PKCH465CH460PKCH485KED350 RadialG1255
	E868	5*10*10	6540273	CepilloL1323AL282
	E755	6*8*13  FH28	6540563	RadialG600G1001AG1251AG1005G1151AG1155A
		E765	6*8*11	6540743
E779		5*8*11	6540103	TaladroG1250 FresadoraR155RE155PulidoraSP1800A



## Ryobi













Figura	Ref.	Medidas	Original	Aplicaciones
	E864	6 * 9 * 15	6541163 6541223	Martillo ED205VRK
	E866	6 * 9 * 15	6540993	Sierra cadena HC310-HC360-HC410-HC536
	E869	6 * 6,5 * 10,5	642054073	Lijadora S500
	E870	6 * 8 * 12	6540023	Lijadora S550
	E899.04	5 * 8 * 13	6216811	Taladro PD160VR-PD161VR
	E874	7 * 16 * 20	6541373	Radial G1830
		FHB6,3		
	E651	4,9 * 7,9 * 10	8066810001	Radial SG1155
	E899.15	6 * 9 * 12	6541465	Radial G1156-G1256-SG1156-SG1256
		6541557		
	E796	7 * 17 * 17	8063200002	Radial SG2320



## Skil

Figura	Ref.	Medidas	Original	Aplicaciones
	E732	6,4 * 10 * 19,5	364826	Martillo 736H
	E740	4,7 * 6,3 * 13	63905	Taladro 63905
	E1766	6,4 * 9,5 * 24	307161	
	E773	6,5 * 10 * 18		Sierra 555H

**Skil**

Figura	Ref.	Medidas	Original	Aplicaciones
	E872	6,3 * 6,3 * 14 FHB28	2610354	Atornillador 6906
	E987	4,7 * 6,4 * 13	372317	Atornillador 1489H
	E1128	6,3 * 16 * 23 FH6,3	1607014171	Radial 9551-9777-9790-9795-HD9661-9762
	E1510	5 * 8 * 18 FH2,8/FM2,8	1607014116	Radial SKILL 9021-9200-9210
	E1511	5 * 8 * 15 FM4,8	2610376111	Lijadora 666H1
	E512	6,4 * 10 * 15 FM4,8	2610366280	Cepillo 50098H1 Lijadora 1400H1.51405H4
	E513	6 * 7 * 11	2610373248	Cepillo 500940.1-94H1
	E1640	5 * 8 * 15	1617014136	Martillo 1745-1750
	E515	6 * 16 * 19	2610374808	Radial 9645-9650-9660-9665-9750-9760
	E516	6,3 * 12,5 * 20	2610360461	Sierra 1886-1899
	E917	5,5 * 8,5 * 14 FH2,8	2610383784	Radial 6470-9114-9115-9116-9125-9126
	E520	6,3 * 16 * 20 FHB4,8	2610387232	Radial 9755-9770-9775
	E768	5,5 * 8,5 * 15	2610386473	Radial 6470-6475-6490-9115-9116-9125-9126





## Stayer



















Figura	Ref.	Medidas	Original	Aplicaciones
 	E723	9 * 14 * 22	78700980	Radial 208
	E763	6 * 10 * 20		Pulidora LU80 Radial Z10
	E749 E1749	6 * 14 * 22	21000960 24700970	Lijadora LU170-LU172 Radial B/8-SA10A-SA12A-SA10AL-SA12AL-SA25-SA230 SA180-Z7-Z9-Z20-Z25-SA10-SA12-B6-Z13
	E734	6 * 8 * 15	35000300	Cortasetos T500-T550-T600-TS50/60 Lijadora LRT150-S230 Radial AG680-SA710 Taladro TM100-TM101-TM350-W551-W1000A
	E738 E1738	9 * 14 * 22  FH6,3	29000900	Radial SA290/293/295/297
	E762	6 * 6 * 11,5	30300900	Atornillador 383 Cepillo 980-980B-982 Lijadora TM8A-TM80A-TM10A2V-L0M412-413 Martillo P20E-P230RE-MP301-MP302 Radial SA100-SA115-SA107-Z202-203-207 Taladro percusión TM327-TM328-TM340-TM366-TM345-346 T5001-TC4002-TC7000-9000-TM10AP/S-8S
	E764	6 * 6 * 12,5	20500900	Fresadora PR1 Lijadora LOM10-12-L0M412/13 Radial LA7-SA125/126/127-SD25A-SD125/251-Z2027203/207A
	E769	6 * 6 * 15	21200970	Radial SA7-Z202-SA107-SA125/126/127
	E659	6 * 8 * 15 FH2,8	4.810.871.0	Radial Mini SA900-901-1201
	E826	6,3 * 8 * 12,5		Radial FH720
	E243	6,5 * 8 * 15  FH2,8		Radial SA720
	E648	7 * 18 * 19		Radial



Figura	Ref.	Medidas	Original	Aplicaciones
	E500	6,4 * 10 * 19	3017005	Cepillo A92-AP98-P75 Fresadora E70N Lijadora banda M75 Lijadora orbital H71-AJ97 Pulidora K75 Sierra circular V79 Tronzadora AL96-AS93-TM43D-BL96-TS48D-LR86C-RT91C
	E506	5 * 9 * 15	3517016	Cepillo CE35E
	E501	5 * 6 * 16	3517004	Cepillo CE89C-J71
	E504	5 * 6 * 17	1017001	Fresadora F71
	E502	6 * 12 * 19,5	7017003	Sierra circular G71
	E507	6,6 * 12 * 21	3317022	Fresadora FR160P Tronzadora TM33-43-TS33-48
	E503	5 * 6 * 15	1217006	Fresadora Z81N-C93N Lijadora A197-A197N-AK97-AB11 Radial 181N Ranuradora 081N
	E505	5 * 9 * 15,5	7917010	Fresadora FR92D/29C-RA17D-R056D-DE87C-RT88C-CR94D Ranuradora AB11C
		FH28		
	E508	6,4 * 10 * 22,5	46.17.030	Lijadora RT-RTE-PD-PDE-LR-676-LRE86C
	E550	5 * 11 * 19	92.17.035	Fresadora, Cepillo Lijadora AB111N-CE120P-FR129N-FR156N FR192N-FR217S-FR292R-GR120P Radial y Pulidora
		FH28		







## Varios

Figura	Ref.	Medidas	Original	Aplicaciones
	E719	5 * 10 * 18	BAIER NEUMAC	Rozadora MF63 Rozadora
	E980	5 * 6,4 * 9,5	BAX	Rasqueteadora 7L
	E994	6 * 9 * 29	CONFORT	Aspirador
	E753	8 * 12 * 23	FRAN	Pulidora
	E1982	7,8 * 9,8 * 20	MACROSA	Rozadora
	E752	6 * 10 * 26,5	NUMAX SUPERC.	Aspirador Aspirador
	E1707	6,3 * 19 * 28,5	WACKER	Convertidor frecuencia
	E751	6,3 * 10 * 20	BAIER	Aspirador BSS287-BSS404 Martillo BBH290E-BMH601 Sierra EHS2LEHS700
		FHB4,8		
	E963	5 * 10 * 17	IMPEX	Rozadora
	E729	6 * 12 * 22	MAPELLI	Bomba PLM1
	E744	5,5 * 7 * 16	MILLERF.	Mod. 680
	E993	6,3 * 11 * 23	OCLOMAT	Aspirador
	E226	6,3 * 8 * 16	DNA	Taladro CU10



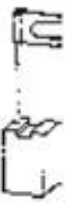

## Varios

Figura	Ref.	Medidas	Original	Aplicaciones
	E758	5 * 7,8 * 18	EINPORT	Fresadora F2
	E746	6 * 12 * 20	MILLERF.	Sierra 800
	E996	6,3 * 6,3 * 13	NUMAX	Aspirador
	E997	5 * 5 * 14	NUMAX	Aspirador
	E1865	6,4 * 12,5 * 22	WACKER	Martillo EBH10
	E1874	8 * 16 * 22	WACKER	Martillo EH23/220
	E975	6,4 * 11,5 * 30	GHEBU	Aspirador
	E998	6 * 7,5 * 20	ION	Motor 1/10
	E990	2,6 * 4 * 8	PHILIPS	Afeitadora
	E995	6 * 10 * 32/37	Nifisk	Aspirador

## > Equivalencias escobillas

Máquina	Refer.
<b>AEG</b>	
AG20	E320-1320
AG100	E1366
AG715	E1361
AG805	E1361
AG1200	E1366
AG1300	E1366
AGV20	E320-1320
B2.16	E306-1306
B2.400	E1300
B2.480	E1300
B4	E1307
B500	E332
B6	E1300
B8A	E304-1304
B10	E304-1304
B16	E306-1306
B2E.13	E305-1305
BBS100	E302-1302
BBSE100	E335-1335
BE570	E399.8
BE6	E1300
BE600	E399.8
BE630	E332
BE8	E1300
BE10	E338-1338
BE13	E340-1340
BH22E	E332
BH24	E332
BH25S	E327-1327
BS6A	E1300
BS10A	E301-1301
BSPE100A	E309-1309
BSPE100X	E309-1309
BV16A	E306-1306
BV26	E1307
BV32	E1307
BWE6	E1300
BWZ6B	E1300
BWZ16	E1307
BZ6	E1300
BZ10	E304-1304
BZ16	E306-1306
BZ22	E1307
D10-800	E332
DBE	E345-1345
DKE1300	E1366
DX225	E321-1321
DZ10	E399.8
EBS4	E1300
EH82	E1319
EH82-1	E305-1305

Máquina	Refer.
EH102	E305-1305
EH700R	E334-1334
EH821M	E305-1305
EH822	E334-1334
EH825	E334-1334
ESB6	E304-1304
ESB8	E304-1304
EX400	E340-1340
EXE400	E340-1340
FB8	E308-1308
FBE/M	E345-1345
FSP100X	E309-1309
FSPE100	E309-1309
FSTE60	E309-1309
G10A	E301-1301
GS330	E308-1308
GS400	E309-1309
GSL500	E309-1309
GSZ250	E1325
GSZ420	E1325
H500	E340-1340
H750	E1319
HB750	E1319
HBE800	E1319
HBS65	E351-1351
HBS100	E335-1335
HBS2110	E316-1316
HBSE65	E335-1335
HBSE100	E335-1335
HE800	E1319
HES40	E302-1302
HES50	E302-1302
HES65	E302-1302
HK50	E1322
HK55	E1322
HK55	E305-1305
HK65	E1322
HK66	E345-1345
HK66S	E1322
HK66SE	E305-1305
HK75	E1322
HK125A	E1319
HK160A	E314-1314
HK190	E316-1316
HK201	E1325
HK240	E323-1323
HK575	E1322
HKE66	E345-1345
HKS52	E345-1345
HKS66	E345-1345
HKS75	E1322
HKSE66	E345-1345

Máquina	Refer.
HS40	E317
HS50	E317
HS60	E317
HS70	E317
HTH75	E314-1314
KES36	E1312
KN1.25	E308-1308
KN1.5	E308-1308
KN2	E309-1309
KN2.5	E1325
KNS2	E309-1309
KS1.2	E308-1308
KS1.6	E308-1308
KS2.5	E309-1309
KS2.5	E1325
KS3.5	E1325
KS35	E342-1342
KSS1.6	E308-1308
KSS1.6	E309-1309
KSS2.5	E308-1308
KSS2.5	E309-1309
NT900	E355-1355
NTE900	E355-1355
OF450	E309-1309
OF550	E348-1348
OFEG500	E309-1309
OFEG30	E348-1348
OFEG50	E348-1348
OFS50	E348-1348
OME500	E309-1309
OX160	E1319
OX200	E327-1327
OX250	E327-1327
OX260	E327-1327
OX360	E327-1327
P18T	E326
PAD12	E326
PB65	E453
PDE10	E399.8
PDE13	E399.8
PDE16	E399.8
PES9.6T	E326
PES12T	E326
PH3	E1366
PH5	E453
PH38	E327-1327
PH200	E321-1321
PH200	E327-1327
PH240D	E327-1327
PH350	E327-1327
PH350RX2	E1366
PHD26	E327-1327

Máquina	Refer.
PHD38	E327-1327
PHE5H	E453
PHE16	E1319
PHE16RLN	E338-1338
PHE20	E321-1321
PHE20RL	E1319
PHE20RL	E340-1340
PHE20RLRLN	E338-1338
PHE26-911	E1366
PHE26R	E1366
PHE26SDS	E321-1321
PHE30RX2	E1366
PHE200	E321-1321
PHE350RX2	E1366
PHLE20R	E338-1338
PHM	E357-1357
PN12PP	E326
PN20	E332
PN24	E332
PN30	E332
PN2000	E332
PN220	E332
PN2200	E332
PN2200	E399.8
PN3000R2	E302-1302
PN3000	E1366
PN3500	E1366
PSX18	E326
S12T	E326
S14.4T	E326
S230	E320-1320
S600	E309-1309
SB2	E302-1302
SB16	E304-1304
SB22	E1361
SB218	E340-1340
SB235D	E305-1305
SB350	E1300
SB350RL	E301-1301
SB2-16	E1300
SB2-16	E399.8
SB2-16N	E302-1302
SB2.350	E301-1301
SB2.35D	E306-1306
SB2.400	E1300
SB2.401	E301-1301
SB2.420	E304-1304
SB2.420S	E301-1301
SB2.480	E1300
SB2.500	E338-1338
SB2.500S	E1300
SB2.501	E301-1301





Máquina	Refer.
SB2-550	E399.8
SB2-570	E332
SB2.600	E302-1302
SB2-630	E332
SB2E.13RL	E1300
SB2E.16	E301-1301
SB2E.16RL	E1300
SB2E.20	E306-1306
SB2E.20R	E1366
SB2E.20RA	E1366
SB2E.20RL	E306-1306
SB2E.20RS	E1366
SB2E.22R	E1366
SB2E.22R-911	E1366
SB2E.24RT	E1366
SB2E.24RT-911	E1366
SB2E.380	E1300
SB2E.400	E1300
SB2E.450	E1300
SB2E.451RL	E301-1301
SB2E.480	E1300
SB2E.500	E1300
SB2E.500RL	E1300
SB2E.501	E301-1301
SB2E.550	E302-1302
SB2E.600	E301-1301
SB2E.600R	E302-1302
SB2E.600RL	E1300
SB2E.601RL	E305-1305
SB2E.620R	E1300
SB2E.650R	E302-1302
SB2E.650R	E340-1340
SB2E.650RL	E302-1302
SB2E.651	E306-1306
SB2E.680	E301-1301
SB2E.680R	E302-1302
SB2E.700	E302-1302
SB2E.701	E306-1306
SB2E.750	E301-1301
SB2E.751	E306-1306
SB2E.800RS	E1366
SB2E.801	E306-1306
SB2E.801RL	E306-1306
SB2E.901	E306-1306
SB2E.1000RS	E1366
SB2E.1001	E306-1306
SB2E.1001RL	E305-1305
SB2E.1001RL	E306-1306
SB2E20	E305-1305
SB2E20RL	E305-1305
SB2EA.450	E1300
SB2EA.600	E301-1301
SB2EIGRL	E340-1340
SB2R13RL	E340-1340
SB2R16RL	E340-1340
SB4.500	E301-1301

Máquina	Refer.
SB4.550	E301-1301
SB6.100	E332
SB6.500R	E338-1338
SBE.15R	E302-1302
SBE16	E399.8
SBE.18R	E302-1302
SBE.18R	E338-1338
SBE.380	E1300
SBE.380R	E338-1338
SBE.380RL	E301-1301
SBE.400R	E338-1338
SBE.401RL	E1300
SBE.420	E301-1301
SBE.420RL	E1300
SBE.450R	E338-1338
SBE.480R	E338-1338
SBE.490R	E332
SBE.500R	E332
SBE.500R	E338-1338
SBE.500RLS	E1300
SBE.500RT	E338-1338
SBE.520R	E302-1302
SBE.550	E332
SBE.570	E332
SBE.600	E332
SBE.630	E332
SBE.630	E399.8
SBE.635	E332
SBE.635	E399.8
SBE10RLN	E338-1338
SBE380R	E338-1338
SBE400R	E338-1338
SBE450R	E338-1338
SBE480R	E338-1338
SBE480R	E338-1338
SBE500R	E338-1338
SBE500RT	E338-1338
SBE2.400N	E340-1340
SE800M	E309-1309
SP2.16	E336-1336
SSP2.800	E340-1340
SSPE800	E305-1305
SSPE800M	E305-1305
ST500	E340-1340
STEP400	E340-1340
STEP500	E340-1340
STEP500A	E340-1340
STEP600	E340-1340
STPE400	E340-1340
STPE400A	E340-1340
STPE60	E302-1302
STS2330	E302-1302
STS250	E317
STS330	E302-1302
STS350	E302-1302
STS380A	E340-1340

Máquina	Refer.
STSE250	E317
STSE350	E306-1306
STSE400A	E340-1340
STSE60	E302-1302
STSZ350	E302-1302
TC18E1	E338-1338
TCE1800	E338-1338
TSDA2000	E320-1320
TXE150	E340-1340
UBSE8RL	E340-1340
USB380E	E338-1338
USB520E	E338-1338
USE600	E399.6
USE800	E399.6
UST500	E340-1340
UST500EP	E340-1340
UWS630	E309-1309
VS130	E317
VS14	E340-1340
VS230	E340-1340
VS250	E1319
VS260	E309-1309
VS280	E305-1305
VS350	E302-1302
VS360	E309-1309
VSE20	E340-1340
VSE230	E340-1340
VSL115	E309-1309
VSLE115	E309-1309
VSLE125	E309-1309
VSS20	E340-1340
VSS230	E340-1340
VSS250	E1319
VSS260	E309-1309
VSS260	E333-1333
VSS280	E305-1305
VSSE20	E340-1340
VSSE260	E333-1333
VSSE280	E305-1305
WP250	E1325
WP400	E1324
WP1900	E331-1331
WPZ450	E1307
WS115	E309-1309
WS7-115	E1337
WS125	E309-1309
WS7-125	E1337
WS8-115	E1337
WS8-125	E1337
WS180N	E320-1320
WS190S	E320-1320
WS230N	E320-1320
WS230S	E320-1320
WS330	E308-1308
WS480	E310-1310
WS500	E310-1310

Máquina	Refer.
WS550	E310-1310
WS600	E309-1309
WS630	E309-1309
WS710	E309-1309
WS751	E321-1321
WS900	E1307
WS1000	E1366
WS1201	E331-1331
WS1800	E320-1320
WS1801	E320-1320
WS1900	E1312
WS1900	E320-1320
WS2000N	E320-1320
WS2000S	E1312
WS2001	E320-1320
WS2100	E1312
WS2300	E1307
WS2300S	E1312
WSA1200	E331-1331
WSA1201	E331-1331
WSA1800	E320-1320
WSA1801	E320-1320
WSA1900	E1312
WSA2000	E1312
WSA2000N	E320-1320
WSA2000S	E1312
WSA2001	E320-1320
WSA2100	E1312
WSA2100M	E358-1358
WSA2100S	E1312
WSA2300	E1307
WSA2300	E358-1358
WSA2300S	E1312
WSAE2300N	E320-1320
WSAE2301	E320-1320
WSAM1900	E320-1320
WSB180S	E320-1320
WSB190	E320-1320
WSB230N	E320-1320
WSB230S	E320-1320
WSB1800	E320-1320
WSB1801	E320-1320
WSB1900	E1312
WSB2100	E1312
WSB2100S	E1312
WSB2300	E1307
WSBA1800	E320-1320
WSBA1801	E320-1320
WSBA1900	E1312
WSBA1900M	E320-1320
WSBA2000	E1312
WSBA2000N	E320-1320
WSBA2100	E1312
WSBA2100S	E1312
WSBA2300	E1307
WSC2300S	E1312



Máquina	Refer.
WSCE1300	E1366
WSE115	E309-1309
WSE125	E309-1309
WSE180	E331-1331
WSE601M	E309-1309
WSE602M	E309-1309
WSE800C	E309-1309
WSE800M	E309-1309
WSE801	E309-1309
WSE802	E309-1309
WSE9-125	E1337
WSE1200C	E1366
WSE1300	E1366
WSE2300N	E320-1320
WSE2301	E320-1320
WSL115	E309-1309
WSL115XS	E309-1309
WSL125S	E309-1309
WSL125XL	E1366
WSL180	E320-1320
WSL230	E320-1320
WSL600	E309-1309
WSLB230	E320-1320
WSLE115	E309-1309
WSLE115M	E1362
WSLE125	E309-1309
WSS20	E305-1305
WSS22	E305-1305
WSSCE1300	E1366
WSSE20	E305-1305
WSSE22	E305-1305
WS-WSB	E1312

<b>B &amp; D</b>	
10GM	E202
10HM	E202
13GD	E202
13HG	E202
13HG2	E202
13HM2	E202
16HG	E202
16HG2	E202
23.2V	E217
80PLA	E211
8GM	E202
1707	E913
2032	E223
2269	E967
2271	E966
2279	E967
4279	E879-1879
5014	E224
5019	E1942
5054	E224
5096	E1942
5097	E1942

Máquina	Refer.
5098	E1942
5099	E1942
5411	E222-1222
5413	E222-1222
5512	E222-1222
5932	E220-1220
5933	E220-1220
6139	E211
6140	E211
7308	E206
7310	E206
7320	E206
7394	E206
8209	E240
8255	E240
127167	E967
127194	E967
374453	E242
374455	E227
730807	E206
ANS	E217
AST4A	E227
BD5	E225
BD11	E225
BD11B	E222-1222
BD12	E222-1222
BD12A	E222-1222
BD14	E222-1222
BD59A	E230
BD66A	E205
BD83	E201
BD85	E235
BD99E	E201
BD124	E227
BD136RS	E225
BD140RT	E225
BD169	E227
BD170	E227
BD175	E227
BD179	E227
BD180E	E227
BD190	E242
BD230	E225
BD240RT	E225
BD252	E222-1222
BD255	E222-1222
BD273	E227
BD280	E237
BD282	E237
BD290	E242
BD290E	E237
BD292E	E242
BD292EA	E237
BD308RE	E226
BD308REA	E225
BD309R	E226

Máquina	Refer.
BD309RA	E225
BD309RD	E226
BD310RE	E226
BD310REA	E225
BD423	E224
BD425RE	E224
BD547E	E201
BD557	E242
BD559	E242
BD561	E242
BD562	E242
BD564	E242
BD575	E896
BD651	E941
BD652	E941
BD654	E941
BD661	E242
BD662	E242
BD664	E242
BD700	E230
BD710	E201
BD711	E201
BD713	E201
BD720	E201
BD750	E201
BD755	E242
BD765	E242
BD800	E230
BD1000A	E225
BD1000	E226
BD2018	E220-1220
BD2023	E220-1220
BD4000A	E242
BDT140RT	E225
BL135	E227
BL400A	E242
CD400A	E227
CD500	E222-1222
CON170	E227
CON561	E242
CP135	E227
CP380	E242
D10	E201
D13	E201
D13PV	E201
D38	E230
D43	E242
D60	E242
D77	E205
D101	E201
D102	E201
D104VR	E201
D108	E201
D112	E201
D130R	E225
D135R	E225

Máquina	Refer.
D136RS	E225
D140RT	E225
D152G	E225
D154RG	E225
D200S	E201
D201	E201
D202	E201
D205	E201
D206	E201
D206A	E205
D220	E225
D230	E225
D240RT	E225
D302E	E226
D302ES	E225
D303	E226
D304E	E226
D306E	E226
D308	E226
D309	E226
D310	E226
D400	E200
D409	E205
D423	E224
D425RE	E224
D500	E200
D510	E205
D520	E200
D640	E200
D700	E200
D720	E200
D820	E200
D43004	E912
D67504	E912
DN5	E225
DN10	E210
DN11	E225
DN12	E236
DN17	E213
DN18	E213
DN20	E213
DN31	E205
DN34	E205
DN35	E205
DN36	E205
DN38	E201
DN39	E201
DN41	E227
DN44	E205
DN46	E205
DN47	E205
DN48	E205
DN49	E227
DN54	E205
DN55	E205
DN56	E205





Máquina	Refer.	Máquina	Refer.	Máquina	Refer.	Máquina	Refer.
DN57	E230	GC400	E205	GT534	E242	KG100	E898-1898
DN59	E230	GC600	E205	GT535	E242	KG1820	E220-1220
DN66	E205	GCT330	E205	GT540	E242	KG1825	E220-1220
DN75	E205	GCT400	E205	GT545	E242	KS400	E242
DN83	E201	GCT600	E205	H41	E227	KS575	E896
DN85	E235	GD10	E200	H68	E205	KS745	E242
DN98	E201	GD20	E200	HB43	E242	KS755	E242
DN99E	E201	GD47	E205	HB53	E242	KS765	E242
DN170	E227	GD48	E205	HD25D	E202	LEM	E211
DN175	E227	GD310	E205	HD75	E207	LR100	E205
DN180E	E227	GD315	E205	HD86	E207	LR101	E205
DN183	E220-1220	GD3038	E201	HD1215	E218	LR1500	E205
DN230	E201	GD3115	E213	HD1300	E200	LUM	E211
DN231	E201	GD3116	E213	HD2040	E204	M1800	E220-1220
DN273	E227	GL200	E242	HD2062	E207	MAG101	E209
DN277E	E227	GL300	E242	HD2075	E207	MAG101A	E236
DN441	E205	GL320	E242	HD2086	E207	MAG102	E209
DN521	E205	GL325	E242	HD2120	E204	MC550E	E201
DN522	E205	GL330	E242	HD2150	E214	ORL	E211
DN523	E205	GL335	E242	HD2180	E214	ORS	E211
DN524	E205	GL340	E242	HD2230	E214	P1121	E222-1222
DN547E	E201	GL440	E242	HD3180	E213	P1142	E228
DN710	E205	GL445	E242	HD3230	E213	P1142A	E967
DN730	E205	GL520	E242	HD5465	E219	P1144	E228
DN800	E230	GL530	E242	HD5465-01	E219	P1144A	E967
DN810	E230	GL535	E242	HV7P	E202	P1145	E228
DN820	E230	GL540	E242	HV7V	E202	P1145A	E967
DN840	E230	GL544	E242	HV18V	E202	P1146	E228
DN2023	E220-1220	GL545	E242	HV25D	E202	P1146A	E967
DNJ50	E201	GL546	E242	HV25T	E202	P1149	E228
DNJ52	E201	GL550	E242	KA110	E227	P1149A	E967
DNJ64	E201	GL555	E242	KA175	E227	P1151	E228
DNJ72	E201	GL560	E242	KA180	E227	P1151A	E967
DNJ74	E201	GL565	E242	KA185	E227	P1167	E228
DNJ76	E201	GL570	E242	KA186	E227	P1167A	E967
DNJ84	E201	GL575	E242	KA190	E242	P1168	E228
DNJ450	E205	GL580	E242	KA196	E227	P1168A	E967
DNJ452	E205	GL585	E242	KA200	E227	P1169	E228
DNJ454	E205	GL595	E242	KA210	E227	P1169A	E967
DNJ550	E201	GL650	E242	KA220	E227	P1177	E967
DNJ700	E201	GL660	E242	KA225	E227	P1178	E228
EMD402	E228	GL670	E242	KA230	E227	P1178A	E967
F7	E201	GM.2V	E202	KA273	E227	P1179	E228
F8	E201	GS330	E205	KA290	E242	P1179A	E967
F10	E201	GS400	E205	KA292	E242	P1221	E222-1222
F10P	E201	GS600	E205	KD651	E941	P1224	E222-1222
F13P	E201	GS1600	E213	KD652	E941	P1229	E222-1222
F210	E201	GT410	E242	KD654	E941	P1243	E228
F212	E201	GT420	E242	KG11	E222-1222	P1243A	E967
F213	E201	GT425	E242	KG14	E222-1222	P1246	E228
F214	E201	GT430	E242	KG65	E243	P1246A	E967
F220	E201	GT435	E242	KG68	E222-1222	P1249	E228
G1500	E213	GT440	E242	KG72	E243	P1249A	E967
GA100	E230	GT520	E242	KG75	E222-1222	P1512	E222-1222
GC300	E205	GT524	E242	KG85	E898-1898	P1521	E222-1222
GC380	E205	GT530	E242	KG90	E243	P1522	E222-1222



Máquina	Refer.
P1528	E222-1222
P1529	E222-1222
P1612	E222-1222
P1621	E222-1222
P1622	E222-1222
P1625	E222-1222
P1804	E220-1220
P1808	E220-1220
P2123	E222-1222
P2128	E222-1222
P2167	E228
P2167A	E967
P2168	E228
P2168A	E967
P2169	E228
P2169A	E967
P2172	E228
P2172A	E967
P2177	E228
P2177A	E967
P2179	E228
P2179A	E967
P2182A	E967
P2221A	E222-1222
P2224A	E222-1222
P2229A	E222-1222
P2243	E228
P2243A	E967
P2246	E228
P2246A	E967
P2249	E228
P2249A	E967
P2271A	E966
P2521A	E222-1222
P2612A	E222-1222
P2615A	E222-1222
P2616A	E222-1222
P2621A	E222-1222
P2622A	E222-1222
P3201	E220-1220
P3202	E220-1220
P3701	E207
P3703	E230
P3710	E956
P3802	E220-1220
P3901	E207
P3902	E220-1220
P3902A	E879-1879
P4402	E201
P5321	E896
P5404	E225
P5404	E222-1222
P5411	E222-1222
P5412	E222-1222
P5413	E222-1222
P5415	E222-1222

Máquina	Refer.
P5416	E225
P5416B	E222-1222
P5417	E225
P5417B	E222-1222
P5426	E222-1222
P5427	E222-1222
P5501	E236
P5502	E209
P5504	E222-1222
P5512	E222-1222
P5513	E222-1222
P5516	E222-1222
P5702	E215-1215
P5703	E215-1215
P5706	E215-1215
P5721	E879-1879
P5722	E221-1221
P5722A	E220-1220
P5723	E879-1879
P5724	E220-1220
P5731	E220-1220
P5732	E220-1220
P5741	E220-1220
P5751	E220-1220
P5752	E221-1221
P5901	E216-1216
P5902	E215-1215
P5903	E215-1215
P5906	E215-1215
P5911	E216-1216
P5912	E215-1215
P5913	E215-1215
P5916	E215-1215
P5921	E221-1221
P5921A	E879-1879
P5922	E220-1220
P5923	E879-1879
P5924	E220-1220
P5931	E879-1879
P5932	E220-1220
P5933	E221-1221
P5933A	E220-1220
P5941	E221-1221
P5951	E879-1879
P5952	E220-1220
P6103	E235
P6201	E211
P6301	E241
P6302	E241
P6303	E204
P6304	E204
P6305	E204
P6601	E211
P7101	E211
P7301	E202
P7302	E202

Máquina	Refer.
P7303	E202
P7305	E202
P7306	E202
P7307	E202
P7308	E202
P7311	E967
P7312	E967
P7314	E967
P7315	E225
P7318	E225
P7319	E225
P7701	E879-1879
P7801	E210
P8000	E224
P8016	E224
P8017	E224
P8020	E224
P8021	E224
P8022	E224
P8023	E941
P8024	E941
P8025	E941
P8027	E941
P8042	E1942
P8046	E1942
P8301	E210
P8401	E201
P8402	E210
PAG617	E216-1216
PAG618	E216-1216
PAG620	E215-1215
PAG622	E215-1215
PAG820	E215-1215
PAG822	E215-1215
PL10	E228
PL10A	E967
PL15	E228
PL15A	E967
PL28A	E941
PL30	E201
PL31A	E242
PL38	896
PL50	E241
PL80	E225
PL80AB	E222-1222
PL82	E222-1222
PL85	E220-1220
PRO2000	E216-1216
R015	E210
RW500	E224
S450	E222-1222
S900	E220-1220
SAG500	E210
SAG550	E210
SMEA/B	E212
SMEA/C	E212

Máquina	Refer.
SPEC290	E242
SPEC292	E242
SPEC375	E242
SPEC376	E242
SPEC377	E242
SPEC378	E227
SPEC475	E242
SR200	E201
SR210PE	E201
SR283A	E220-1220
SR300	E230
SR400	E241
SR410E	E227
SR500	E235
SR700	E230
SR800E	E225
SR900	E225
SR905R	E225
SR906S	E225
SR910RT	E225
SR930RLE	E226
SR930RLEA	E225
SR935R	E226
SR935RA	E225
SR940E	E226
SR940EA	E225
SR945E	E226
SR945EA	E225
SR950RE	E224
ST10	E230
ST20	E242
ST22	E242
ST23	E242
ST25	E242
ST7V	E202

BOSCH	
1604.321900	E101
1607.000.352	E199.4
1607.000.994	E199.4
1607.014.100	E111-1111
1607.014.101	E104
1607.014.102	E107-1107
1607.014.103	E112-1112
1607.014.106	E123-1123
1607.014.107	E124-1124
1607.014.108	E112-1112
1607.014.115	E181
1607.014.116	E114-1114
1607.014.117	E1109
1607.014.122	E124-1124
1607.014.125	E123-1123
1607.014.126	E124-1124
1607.014.129	E140-1140
1607.014.130	E1128
1607.014.131	E114-1114





Máquina	Refer.	Máquina	Refer.	Máquina	Refer.	Máquina	Refer.
1607.014.133	E161	2604.321913	E109-1109	1203	E107-1107	1508	E123-1123
1607.014.137	E1146	2604.321914	E118	1204	E101	1520	E103
1607.014.138	E1152	2604.321915	E186	1205-1206	E103	1525	E111-1111
1607.014.143	E140-1140	2604.321917	E149	1207	E123-1123	1526	E108
1607.014.144	E167-1167	2604.321925	E340-1340	1209	E124-1124	1527	E104
1607.014.145	E167-1167	2604.321927	E199.6	1210-1211-1212	E141	1528	E103
1607.014.147	E1129	2607.014.000	E144	1270	E131	1529	E108
1607.014.148	E1146	2607.014.001	E149	1285-1286	E101	1530	E103
1607.014.151	E1129	2607.014.002	E1109	1287	E101	1530	E141
1607.014.154	E1128	2607.014.004	E160	1288	E100	1531	E124-1124
1607.014.162	E1199.3	2607.014.005	E186	1289	E101	1532	E123-1123
1607.014.168	E1128	2607.014.016	E109-1109	1300	E107-1107	1533	E141
1607.014.171	E1128	2607.034.900	E138	1301	E107-1107	1551-1553-1556	E134
1607.014.172	E1129	2607.034.901	E138	1302	E107-1107	1557	E134
1607.014.173	E1129	2610.908.678	E178	1306-1307	E111-1111	1557	E124-1124
1609.200.634	E130	3604.321012	E140-1140	1308-1309	E111-1111	1559	E134
1609.200.929	E131	3604.321025	E140-1140	1310-1311	E107-1107	1560-1561-1562	E130
1609.201.459	E132	3604.321513	E140-1140	1312-1313	E107-1107	1563-64-65-66	E132
1609.201.460	E132	3604.321514	E184	1314	E107-1107	1575	E108
1609.201.664	E133	3607.014.000	E124-1124	1316	E108	1577-1578	E103
1609.202.417	E130	3607.014.001	E142	1317-1318-19-20	E107-1107	1579	E101
1609.203.195	E775-1775	3607.014.012	E123-1123	1321-1322-23-24	E112-1112	1580	E103
1609.243.000	E134	3607.014.505	E178	1325-1326	E112-1112	1581-1582	E141
1617.000.425	E112-1112	1102	E104	1327	E103	1590	E134
1617.000.525	E199.1	1105	E101	1328-1330	E124-1124	1591	E130
1617.014.106	E115-1115	1106	E103	1331-32-33	E112-1112	1608	E114-1114
1617.014.108	E136.1136	1107	E103	1336	E124-1124	1611	E112-1112
1617.014.110	E107-1107	1108	E103	1337-1338	E114-1114	1612	E114-1114
1617.014.111	E112-1112	1109	E108	1339	E112-1112	1632	E124-1124
1617.014.112	E116-1116	1110	E102	1342	E112-1112	1654	E178
1617.014.114	E109-1109	1111	E102	1347-1348	E114-1114	11205	E115-1115
1617.014.117	E148	1112-1113	E102	1401	E108	11206	E136-1136
1617.014.118	E116-1116	1114-1115	E101	1402	E103	11207	E116-1116
1617.014.122	E140-1140	1116	E108	1403	E102	11208	E136-1136
1617.014.124	E1156	1117	E102	1406-1407	E103	11209	E107-1107
1617.014.126	E1153	1119-1120-1121	E124-1124	1408	E103	11210	E109-1109
1617.014.127	E155	1121	E123-1123	1409	E102	11211	E115-1115
1617.014.131	E174	1122	E100	1412-1413	E103	11214	E107-1107
1617.014.134	E155	1123-1124	E103	1415	E109-1109	11222	E115-1115
1617.014.135	E1120	1125-26-27-29	E109-1109	1416	E100	11302	E107-1107
1617.014.137	E1199.2	1130	E112-1112	1417	E103	11304	E112-1112
1617.014.138	E1199.10	1150-1151	E103	1418	E109-1109	11305	E107-1107
2604.320.902	E103	1152	E102	1419	E100	11306	E136-1136
2604.320.905	E108	1157	E103	1430	E104	AHS36	E186
2604.320.906	E102	1158	E101	1431	E107-1107	AHS40	E186
2604.320.908	E141	1170	E104	1432	E103	AHS45	E186
2604.320.910	E141	1171-1172	E103	1433	E108	AHS48	E186
2604.320.911	E188	1173	E102	1436	E109-1109	AHS55	E186
2604.320.912	E141	1174	E104	1460	E108	AKE30	E140-1140
2604.320.914	E185	1174	E124-1124	1461	E102	AKE35	E140-1140
2604.321.904	E100	1175-1176	E103	1500	E108	AKE40	E140-1140
2604.321.905	E109-1109	1177	E102	1501	E111-1111	CSB5-13	E109-1109
2604.321.907	E109-1109	1178	E103	1502	E104	CSB400	E100
2604.321.909	E100	1179-1181-82-97	E109-1109	1503-1504	E103	CSB420	E100
2604.321.911	E148	1201-1202	E107-1107	1506	E103	CSB450	E100
2604.321.912	E100	1203	E108	1507	E124-1124	CSB450	E101



Máquina	Refer.
CSB460	E100
CSB470-480	E109-1109
CSB500	E109-1109
CSB520	E100
CSB550	E109-1109
CSB560	E109-1109
CSB570	E109-1109
CSB620	E109-1109
CSB650	E109-1109
CSB660	E109-1109
CSB680	E109-1109
CSB700	E109-1109
CSB750	E109-1109
CSB800	E109-1109
CSB850	E109-1109
CSB1000	E109-1109
DB500	E109-1109
E20S	E101
E22SB	E101
E42SB	E101
GOF1200	E184
GOF1300	E184
GOF1600	E112-1112
GOF900	E140-1140
GAH350	E155
GAH500	E155
GAH500	E1109
GAS900	E133
GAS1000	E133
GBH2	E155
GBH2	E114-1114
GBH24	E174
GBH4	E1156
GBH5	E140-1140
GBH5	E1120
GBH5	E1199.10
GBH7	E107-1107
GBH7	E1120
GBH8	E107-1107
GBH10	E1153
GBH11	E1153
GBH2.20REA	E109-1109
GBH2.20S-SE	E155
GBH2.22	E199.1
GBH2.24DFR	E155
GBH2.24	E109-1109
GBH2.24	E155
GBH2SE-1226.5	E155
GBH2SE-1226.6	E109-1109
GBH2SR-1226.7	E109-1109
GBH2SR-1226.8	E155
GBH38	E140-1140
GBH500	E1199.10
GBM1	E160
GBM6	E109-1109
GBM6	E118

Máquina	Refer.
GBM6	E100
GBM10	E109-1109
GBM10	E188
GBM13	E124-1124
GBM13.2	E109-1109
GBM13HRE	E109-1109
GBM16.2E	E124-1124
GBM16.2RE	E123-1123
GBM18	E109-1109
GBM23	E124-1124
GBM23.2E	E123-1123
GBM350RE	E186
GBM350RE	E118
GBM350RE	E149
GBM400	E109-1109
GBM400	E100
GBM450	E100
GBM500	E109-1109
GBM6.2RE	E123-1123
GBM6E-X	E109-1109
GBR14C	E1146
GBS100	E178
GBS75	E109-1109
GDC42	E134
GDS18	E109-1109
GDS24	E123-1123
GDS30	E123-1123
GEB1000	E1129
GEX125	E109-1109
GEX150AC	E109-1109
GEX150ACE	E114-1114
GEX270	E340-1340
GFF22	E167-1167
GFZ14-35	E140-1140
GFZ16-35	E140-1140
GG27LC	E102
GG516	E124-1124
GG516A	E144
GG527	E141
GG56	E123-1123
GG57	E141
GGW10E	E109-1109
GHA500	E109-1109
GH020-31-36-40	E109-1109
GKE35	E140-1140
GKE40	E140-1140
GKF600	E141
GKS24	E174
GKS54	E140-1140
GKS54CE	E161
GKS55	E140-1140
GKS55S	E178
GKS55	E1129
GKS65-CE	E140-1140
GKS65S	E178
GKS66CE	E140-1140

Máquina	Refer.
GKS68	E140-1140
GKS75	E178
GKS85	E178
GMB10	E109-1109
GNA1.6L	E188
GNA1.6L-1534	E114-1114
GNA16	E142
GNA2.5	E124-1124
GNA3.2	E114-1114
GNA3.2	E141
GNA3.5	E141
GNF20CA	E114-1114
GNF65A	E119-1128
GNS14	E119-1128
GOF900	E140-1140
GOF1200A	E184
GOF1300ACE	E184
GOF1600	E112-1112
GOF1700	E112-1112
GP012	E123-1123
GR/SIZE	E124-1124
GRW11E	E123-1123
GRW9	E124-1124
GSA800	E185
GSA900	E124-1124
GSA1100	E184
GSA1300	E775-1775
GSB2	E109-1109
GSB12	E138
GSB13	E109-1109
GSB14	E138
GSB16	E109-1109
GSB16	E118
GSB18	E138
GSB18	E109-1109
GSB20	E109-1109
GSB20	E199.1
GSB22	E199.6
GSB24	E138
GSB90.2E	E123-1123
GSB400	E109-1109
GSB450	E109-1109
GSC1.6	E188
GSC16	E142
GSC2.8	E141
GSC3.5	E124-1124
GSC160	E167-1167
GSF100A	E119-1128
GSF65A	E119-1119
GSG300	E188
GSH3	E1199.2
GSH4	E115-1115
GSH4	E140-1140
GSH5	E140-1140
GSH5	E1120
GSH10	E1153

Máquina	Refer.
GSH11	E1153
GSH27	E112-1112
GSH388	E1199.10
GSH500	E1199.10
GSR5.11	E100
GSR6.6	E103
GSR6.16	E109-1109
GSR6.20	E109-1109
GSR6.25	E109-1109
GSR6.40	E109-1109
GSR8	E109-1109
GSR12	E138
GSR14	E138
GSR18	E138
GSR24	E138
GSR36	E138
GSS14	E149
GSS16	E149
GSS16	E109-1109
GSS23	E149
GSS28	E100
GSS180	E340-1340
GSS230	E109-1109
GSS280	E109-1109
GST54	E100
GST60	E141
GST65	E340-1340
GST75	E340-1340
GST80	E141
GST85	E141
GST100	E185
GST120	E185
GST135	E185
GST2000	E141
GSZ160	E167-1167
GUF22A	E114-1114
GUF4.22	E114-1114
GWB10	E108
GWS5	E167-1167
GWS6	E167-1167
GWS7-115-125	E114-1114
GWS7-115	E1152
GWS7-115-125	E1129
GWS8-115	E1129
GWS8-125	E167-1167
GWS9-125-150	E114-1114
GWS9-125	E1129
GWS10-125	E1129
GWS14-125	E1129
GWS14-125	E1146
GWS14-125	E1168
GWS14-150	E1129
GWS14.150	E1146
GWS14-150	E1168
GWS18	E119-1128
GWS19	E119-1128



Máquina	Refer.	Máquina	Refer.	Máquina	Refer.	Máquina	Refer.
GWS20	E119-1128	PEX125	E149	PSB550	E149	PWS19.230	E119-1128
GWS21	E119-1128	PEX270	E340-1340	PSB680	E109-1109	PWS20.230	E119-1128
GWS23	E119-1128	PEX400	E149	PSB850	E199.6	PWS21.230	E119-1128
GWS24	E119-1128	PEX420	E149	PSB1000	E199.6	PWS500	E114-1114
GWS25	E119-1128	PFZ600	E185	PSB1200	E199.6	PWS550	E114-1114
GWS26	E119-1128	PFZ700	E185	PSF22	E114-1114	PWS550	E199.4
GWS230	E119-1128	PFZ1200	E140-1140	PSS2	E149	PWS600	E114-1114
GWS500	E114-1114	PFZ1300	E140-1140	PSS22	E149	PWS600	E1199.3
GWS580	E167-1167	PFZ1400	E140-1140	PSS23	E149	PWS600	E199.4
GWS650	E114-1114	PH01	E109-1109	PSS28	E149	PWS620	E114-1114
GWS660	E167-1167	PH02	E109-1109	PSS28	E109-1109	PWS620	E1199.3
GWS670	E167-1167	PH015	E109-1109	PSS150	E340-1340	PWS650	E199.4
GWS850	E167-1167	PH020	E109-1109	PSS180	E340-1340	PWS680	E199.4
GWS900	E1129	PH025	E109-1109	PSS200	E340-1340	PWS700	E114-1114
GWS1000	E1129	PH035	E109-1109	PSS230	E101	PWS700	E199.4
GWS1400	E1129	PH050	E109-1109	PSS230	E100	PWS710	E114-1114
GWS2000	E119-1128	PH0100	E149	PSS240	E340-1340	PWS720	E199.4
GWS2300	E119-1128	PH0150	E109-1109	PSS280	E109-1109	PWS1600	E112-1112
GWS2400	E119-1128	PH0200	E109-1109	PST50	E109-1109	PWS1800	E112-1112
HS46	E186	PH0300	E140-1140	PST50	E149	PWS1800	E119-1128
HV78-79-81	E112-1112	PHS35	E100	PST52	E149	PWS1900	E119-1128
KS550	E109-1109	PHS36	E100	PST53	E149	PWS6000	E123-1123
M21-22-42	E102	PHS42	E100	PST54	E100	PWS6000	E199.4
OSB1020	E1129	PHS46	E100	PST55	E100	PWS7000	E199.4
P10-11	E101	PHS56	E100	PST58	E100	RLE	E109-1109
P20-21	E101	PHS66	E100	PST60	E100	SB350	E100
P80	E101	PHS560	E100	PST65	E100	SB400	E100
P120	E101	PKE30	E140-1140	PST550	E149	SH0160	E123-1123
P300-400	E130	PKE35	E140-1140	PST550	E340-1340	SS150	E101
PAH1200	E124-1124	PKE40	E140-1140	PST650	E340-1340	ST350	E100
PAM500	E141	PKF25	E141	PST700	E109-1109	UB2.75	E104
PAS900	E133	PKS38	E109-1109	PST700	E340-1340	UB2.77	E107-1107
PAS1000	E133	PKS40	E109-1109	PST750	E340-1340	UBH2.14	E109-1109
PBH14	E109-1109	PKS46	E109-1109	PST800	E109-1109	UBH2-20	E109-1109
PBH16	E109-1109	PKS52	E140-1140	PST850	E340-1340	UBH3.16	E116-1116
PBH16	E148	PKS54	E161	PST1000	E185	UBH3.20	E116-1116
PBH16	E149	PKS54	E140-1140	PST6500	E340-1340	UBH3.24	E116-1116
PBH20	E109-1109	PKS65	E123-1123	PWS6.115	E114-1114	UBH4.26	E115-1115
PBH20	E155	PKS66	E140-1140	PWS6.115	E1199.3	UBH4.26	E1156
PBH160	E109-1109	POF50	E101	PWS6.115	E199.4	UBH6.35	E136-1136
PBH200	E149	POF52	E141	PWS7.115	E114-1114	UBH10.50	E107-1107
PBH200	E148	POF400	E109-1109	PWS7.115	E199.4	UBH12.50	E107-1107
PBH200	E109-1109	POF500	E141	PWS7.125	E114-1114	USG380	E101
PBH220	E155	POF600	E141	PWS7.125	E199.4	USH6	E136-1136
PBH240	E155	POF800	E140-1140	PWS7.125	E1199.3	USH10	E107-1107
PBH300	E1156	PSB13	E109-1109	PWS8.125	E114-1114	USH27	E112-1112
PBH380	E140-1140	PSB42	E109-1109	PWS8.125	E199.4	USW7	E107-1107
PBS60	E109-1109	PSB350	E109-1109	PWS8.125	E1199.3	USW77	E107-1107
PBS75	E109-1109	PSB380	E109-1109	PWS9.125	E199.4		
PEX11	E109-1109	PSB400	E100	PWS9.125	E1199.3		
PEX11	E149	PSB400	E109-1109	PWS9.125	E1129	<b>CASALS</b>	
PEX12	E149	PSB420	E109-1109	PWS10.125	E1129	13410	E112-1112
PEX15	E149	PSB450	E109-1109	PWS12-180	E123-1123	2T10	E401
PEX115	E109-1109	PSB500	E109-1109	PWS13.125	E1129	2T13	E104
PEX115	E149	PSB500	E340-1340	PWS14.180	E123-1123	2T16	E104
PEX125	E109-1109	PSB550	E109-1109	PWS18.230	E119-1128	2T19	E104
						2T23	E104



Máquina	Refer.
2T8	E400
39U15	E420
3T10	E400
3T13	E400
40U10	E418
AG10	E425
BCA50	E405
BCA56	E405
BCA59	E405
BCE582	E405
BCE682	E405
BDH20.230	E1423
BDH5.115	E405
BG10.115	E1424
BLD180	E421
BLR160	E405
BLR170	E405
BLR250	E405
BSC150	E1424
BTP530	E405
BTP532	E405
BTP540	E405
BTP547	E405
BTP600	E405
BTP650	E405
C25	E405
C500	E421
CA60	E405
CE75	E407
CE82	E407
D115	E422
D178	E413
DB115	E405
DC115	E405
DC125	E405
DC178	E112-1112
DC230	E112-1112
DH100	E405
DL115	E408
DL178	E112-1112
DL230	E112-1112
DM115	E405
DM178	E112-1112
DM230	E112-1112
DN13	E1424
DN20	E1423
DN24	E1423
DN7	E405
DN9	E1424
DS178	E112-1112
DS230	E112-1112
FC14	E401
LB110	E407
LB75	E407
LC100	E407
LC75	E407

Máquina	Refer.
LN216	E401
LN225	E401
LP200	E406
M115	E406
M25	E408
MR25	E405
P20.2RE	E401
PC16	E401
PC35	E104
PE20	E401
PH10	E401
PH13	E401
PH550	E421
PL175	E112-1112
PR170	E407
PR175	E112-1112
PV175	E407
R20	E405
RC140	E112-1112
SC180	E407
SC200	E407
SC230	E407
T10	E400
T23	E419
T26	E112-1112
T32	E112-E1112
T8	E401
TC10	E401
TC13	E401
TC6	E401
TC8	E401
TD13	E401
TH10	E401
TH13	E401
TP12	E401
TP35	E104
VC50	E405
VC60	E405
VC61	E405
VC65	E405
VC66	E405
VC85	E405
VCE682	E1424
VCE782	E1424
VD20.230	E1423
VD20.230L	E1423
VD6.115	E405
VF1000	E1424
VF750	E1424
VG10.115	E1424
VG10.125	E1424
VG8.115	E1424
VG8.125	E1424
VLD230	E421
VLR180	E421
VLR210	E421

Máquina	Refer.
VLR300	E421
VSC50	E1424
VSC70	E1424
VT1000	E1424
VT500	E421
VT502	E421
VT510	E421
VT512	E421
VT514	E1424
VT522	E405
VT524	E1424
VT550	E405
VT622	E425
VT624	E1424
VT652	E405
VT654	E1424
VT750	E1424
VT924	E1424
<b>DEWALT</b>	
BH40B	E1942
BH45EK	E1658
D25002-25003	E230
D25101-2-3-4	E1945
D25201-203	E1945
D25303-4-330	
E1999.2	
D25404-5	E1999.4
D25500	E1942
D25600	E1658
D25830	E1658
D25900	E1999.3
D25940	E1999.3
D28108	E222-1222
D28111-3-6-7	E1999.06
D28127-8-9	E222-1222
D28130-2-3-4-5	E1999.06
D28136-7-9-41	E1999.06
D28151-2	E222-1222
D28153	E1936
D28154-5	E1936
D28156-7	E1936
D28187	E1936
D28400-1	E1999.3
D28410-11	E1999.3
D28413-14	E1999.3
D28421-22-23	E1999.3
D28432	E1999.3
D28750	E1999.3
D61404	E912
DW49K	E220-1220
DW62	E230
DW65	E956
DW133	E222-1222
DW158	E1940
DW159	E1940

Máquina	Refer.
DW165	E1940
DW165	E224
DW168	E967
DW171-73	E967
DW201-2	E967
DW203	E967
DW241	E225
DW217	E899
DW221	E899
DW226	E899
DW236	E899
DW241	E225
DW246	E899
DW248	E899
DW255	E899
DW258	E899
DW263K-4-6	E899
DW268K-9	E899
DW274K-5	E899
DW304K-6	E896
DW319-320	E242
DW321	E222-1222
DW322	E222-1222
DW323	E222-1222
DW324	E222-1222
DW351	E913
DW359	E956
DW365	E913
DW383	E220-1220
DW389	E956
DW401	E222-1222
DW402	E934
DW405	E222-1222
DW411	E934
DW423	E934
DW430	E912
DW431	E912
DW443	E934
DW448	E222-1222
DW450	E222-1222
DW451	E222-1222
DW456	E1936
DW458-A	E898-1898
DW458C	E1936
DW476-6	E879-1879
DW476	E220-1220
DW476QS	E220-1220
DW479	E220-1220
DW490-91	E220-1220
DW492	E220-1220
DW501	E225
DW505KS	E948
DW512	E966
DW514-16	E224
DW523	E224
DW540	E1942





Máquina	Refer.
DW541	E1942
DW543	E1942
DW545	E1942
DW550	E224
DW553	E224
DW557	E941
DW558K	E1895
DW561	E230
DW562	E230
DW563	E230
DW563K	E948
DW563KC	E225
DW566K	E941
DW567K	E941
DW620	E912
DW621K	E912
DW625EK	E913
DW630-32	E1660
DW634	E912
DW650	E935
DW650E	E935
DW675	E912
DW682K	E934
DW685K	E933
DW700	E913
DW704	E956
DW705	E956
DW708	E956
DW806	E222-1222
DW811	E222-1222
DW816	E222-1222
DW818	E222-1222
DW823	E1936
DW824	E898-1898
DW825	E1936
DW826	E1936
DW830	E1965
DW840	E1660
DW840QS	E220-1220
DW841QS	E220-1220
DW849	E896
DW875	E221-1221
DW882	E879-1879
DW886	E210
DW887	E934
TY174	E913
<b>ELU</b>	
BH26	E224
BM20C	E1940
BM21	E1940
BH40-41	E1942
BM43	E1940
BH45EK	E1942
BH46EK	E1942
BM10-11EA	E967

Máquina	Refer.
BM12-14-15-17-18	E899
BM19	E225
BM30	E222-1222
BM33-43	E224
BM6A	E967
BS10-20-25-40-45	E899
DS140	E933
EAG200-4-6	E222-1222
EAG216	E220-1220
ECD300AL308	E967
EHD321-2	E967
EMS705	E956
ES56	E934
ESD700-1-2-5	E967
MBH23	E941
MBH24	E941
MBH25	E941
MBH26	E941
MBH90	E935
MBR100	E934
MFF80	E912
MFF81	E912
MH25	E912
MH151	E913
MH165	E913
MH265	E956
MHB157	E912
MHB158	E912
MOF131	E913
MOF177	E913
MSS810	E896
MSS810	E896
MTS20	E220-1220
MVS156	E912
MVS500	E241
MVS501	E241
MVS93-94	E912
PS174	E913
PS374	E956
SB11	E967
SB13	E225
SB15	E966
SB20-21-22	E1940
SB41	E1940
SB43EC	E224
SB43-50	E1940
SH50	E1942
SH60K	E1895
ST72-74-82-84	E222-1222
VS41	E912
WS11-12	E222-1222
WS13-14	E222-1222
WS22-23-24	E222-1222
WS31-32-41	E1936
WS42E	E898-1898
WS45	E1965

Máquina	Refer.
WS51E	E220-1220
WS52E	E220-1220
WS53	E220-1220
WS53E	E220-1220
WS54	E220-1220
WS55E	E220-1220
WS56E	E220-1220
WS61	E220-1220
WS72115	E222-1222
WS90125	E222-1222
<b>FARCO-TENAX</b>	
1608	E611-1611
AM1676	E112-1112
AM1678	E112-1112
AM1806	E112-1112
AM1808	E112-1112
AM2056	E112-1112
AM2058	E112-1112
AM421	E408
AM451	E405
AM651	E405
AMR421	E408
DS217	E605-1605
LP241	E607
LP804	E407
TL402	E408
TLP632	E104
<b>FEIN</b>	
ASB636	E960
ASB647	E981
ASB648	E981
ASC51	E960
ASC636	E960
ASG648	E981
ASS648	E981
ASSD715	E915
AST636	E977
ASTE649	E981
ASZ51	E960
ASZ636	E960
ASZ648	E981
DS636	E960
DSC637	E960
DSC648	E981
EZ11	E1916
EZ85	E1916
FSC649	E981
MSF642	E1961
MSF649	E981
MSF666	E736-1736
MSF679	E745-1745
MSF636	E977
MSF649	E981
MSH648	E981

Máquina	Refer.
WP012/27E	E1988
WP013-15	E1799.05
WSB8-11	E1799.05
WSB8-115	E1799.05
WSB13-125	E1799.05
WSB25/230	E1986
WSG8-115	E1799.05
WSG9-125	E1799.05
WSG9-70	E1799.05
WSG12-125	E1988
WSG13-125	E1799.05
WSG13-150	E1799.05
WSG13-70	E1799.05
WSG20/230	E1986
<b>FELISATTI</b>	
116TV	E201
200-6/8	E709
30-40-50	E718
A20/6	E985
A20/8	E985
A24/6	E969
AS21	E790
ASSD715	E918
CT176	E760
CT178	E760
CT223	E760
CT232	E760
CT248	E760
CT252	E760
CT253	E760
CT272	E760
CT285	E760
CT511	E760
FEL1	E718
FEL21	E711
FEL22	E760
FEL24	E760
FEL60	E718
M79	E709
MT216KS	E649
SF206	E925
SF208	E925
SF249	E925
SF251	E925
SF509	E925
T777	E969
TP100	E984
TP114	E970
TP115	E711
TP116	E984
TP125	E984
TP126	E984
TP170	E971
TP176	E971
TP190	E709



Máquina	Refer.
TP220	E969
TP220/6	E972
TP220/8	E972
TP226	E969
TP228	E969
TP243	E984
TP257	E984
TP258	E201
TP28	E984
TP31	E919
TP501	E201
TP502	E201
TP513	E971
TP515	E971
TP517	E919
TP521	E984
TP600	E919
TP601	E201
TP602	E919
TP602-1-2	E201
TP616	E201

#### FESTO

ATT52	E952
AXF45	E951
AXP65	E953
AXP85	E953
AXT50	E951
AXT55	E951
BF1E	E1954
DF500Q	E1954
PS1	E603-1603
RAP80	E1954
RAS115	E1954
RO1-WET	E603-1603
RO125	E1954
RO150	E1954
RS1	E951
RS2	E951
RS3	E951
RS4	E951
RSM	E951
RTB	E951
RTM	E951
RTR	E952
RTT	E952
WET2E	E1954
WS0402	E603-1603
WS0502	E603-1603
WS0506	E603-1603
WS0510	E603-1603

#### FLEX

1109FE	E603-1603
BSS1202	E754
BSS1501	E603-1603

Máquina	Refer.
C1302	E754
CB1506	E603-1603
CK603	E775-1775
DH1202	E604-1604
DL9	E600-1600
DL9-K9	E602-1602
F150YFR	E775-1775
F427M	E603-1603
H105M	E603-1603
H127M	E1629
H1206	E754
H1212	E754
H127LM	E1629
K120VE	E603-1603
K2750C	E601-1601
K2765C	E601-1601
L107	E603-1603
L110	E603-1603
L1109	E628
L1309	E1645
L1503	E613
L1509	E628
L2104	E601-1601
L2106	E601-1601
L2108	E601-1601
L2402	E601-1601
L2600	E601-1601
L2806	E601-1601
L2808	E603-1603
L3309	E1645
L3403	E1645
L3410	E1645
LBV1506	E775-1775
LG1507	E603-1603
LG1707FR	E638-1638
LIS06	E603-1603
LK2004	E776
LK2006	E776
LK2008	E776
LK6010	E775-1775
LK604	E775-1775
LP1503VR	E775-1775
LW1202	E754
LW1503	E603-1603
LW2402	E601-1601
LW2602	E601-1601
LW603	E775-1775
M1506FR	E603-1603
MSF130	E613
P120	E603-1603
R1800	E754
R600	E775-1775
RZ600	E775-1775
S110	E603-1603
SL03UE	E603-1603
SR602	E775-1775

Máquina	Refer.
SRA602	E775-1775
SRP602	E775-1775
X1107	E603-1603
XC1506	E603-1603
ZH1206	E754
ZH1208	E754
ZL109	E603-1603
ZL1109	E603-1603
ZL1402	E604-1604
ZL209	E603-1603
ZL2108	E614
ZL2108-K34	E615
ZL2708	E614
ZL404	E604-1604
ZL9	E600-1600
ZLK2008	E776
ZLK604	E775-1775
ZLK610	E775-1775
ZSK602	E775-1775

#### HILTI

DD100	E1622
DD160E	E1641
ST18	E1640
T10	E793-1793
T8	E793-1793
T104	E1623
TE10	E793-1793
TE12	E791-1791
TE14	E1623
TE15	E1623
TE2	E1642
TE24	E1623
TE25	E1609
TE29	E1642
TE2M	E1642
TE42	E774-1774
TE5	E793-1793
TE504	E1623
TE52	E794-1794
TE54	E1623
TE55	E1623
TE704	E1622
TE705	E1622
TE72	E772-1772
TE74	E1622
TE75	E1622
TE76	E1622
TE8	E793-1793
TE804	E1646
TE805	E1646
TE905	E1622
TE92	E792-1792
TP400	E794-1794
TP600	E1646
TP800	E792-1792

Máquina	Refer.
TP804	E792-1792
TP90	E791-1791
TSB24	E1786

#### HITACHI

BLU4	E923-1923
BLUSH3	E798-1798
BLUSN6	E798-1798
BM25	E796-1796
BM25Y	E922-1922
BM50-BM50SA	E922-1922
BUPN3	E922-1922
C10FA	E796-1796
C10FB	E923-1923
C10FS	E922-1922
C10RA	E796-1796
C12	E923-1923
C12FA-Y	E796-1796
C13	E923-1923
C13SA	E796-1796
C13U	E796-1796
C15FB	E796-1796
C6	E922-1922
C6BU	E922-1922
C6SA	E923-1923
C6U	E922-1922
C7	E922-1922
C75B	E923-1923
C75C/D	E922-1922
C7BD/SB	E923-1923
CTBU	E922-1922
C7SC	E922-1922
C8	E923-1923
C8FA-FB-FC-FS	E922-1922
C8U-V	E923-1923
C9	E923-1923
CB10V	E922-1922
CB10VA	E921-1921
CB12V	E922-1922
CB17Y	E922-1922
CB75	E796-1796
CB8	E922-1922
CBC6	E922-1922
CBSC	E922-1922
CC12-Y	E796-1796
CC12SA	E923-1923
CC14	E796-1796
CC14QV-SA	E923-1923
CC16	E796-1796
CD12F	E796-1796
CE16	E921-1921
CJ60	E921-1921
CJ65	E921-1921
CJ65S1	E921-1921
CJ65S2	E1928
CJ65V	E921-1921



Máquina	Refer.	Máquina	Refer.	Máquina	Refer.	Máquina	Refer.
CJ65V2	E1928	DH50	E923-1923	FS10	E798-1798	P100F	E796-1796
CJ65VA	E921-1921	DH55	E923-1923	FSV12	E798-1798	P12R	E796-1796
CJ65VA2	E1928	DMR13	E922-1922	FSV13	E798-1798	P12RA	E796-1796
CJ65VAI/VB	E921-1921	DMT13	E798-1798	FV12T	E798-1798	P20SA	E798-1798
CJ120V	E798-1798	DMT16	E922-1922	G10	E921-1921	P20SB	E921-1921
CM12	E796-1796	DMV16	E922-1922	G12S1-SA-SG	E921-1921	P20SD	E923-1923
CM4	E922-1922	DS9	E799.1	G12S2-SA2-SE	E930-1930	P20V	E798-1798
CM6	E922-1922	DS12	E799.1	G13S1-SA-SB	E921-1921	P30	E922-1922
CN16	E921-1921	DS14	E799.1	G15SA	E922-1922	P40	E923-1923
CN45SA	E923-1923	DS18	E799.1	G15YC	E930-1930	P50	E923-1923
CN60SA	E923-1923	DSV8	E798-1798	G18DF	E923-1923	PDA100D	E921-1921
CP12	E921-1921	DU10	E798-1798	G18SC	E923-1923	PDH125	E922-1922
CP2	E921-1921	DUPN2	E923-1923	G18SD	E923-1923	PDH180C	E796-1796
CR10	E922-1922	DUT10	E798-1798	G18SE	E796-1796	PG21SA	E923-1923
CR12-13	E922-1922	DUT13	E798-1798	G18SE2	E796-1796	PH40F	E922-1922
CR17	E922-1922	DV13	E798-1798	G18SE3	E1699	PH65A	E796-1796
CS280A	E923-1923	DV14-V	E798-1798	G18SF	E796-1796	PR25B	E922-1922
CS28B	E923-1923	DV14DMR	E799.1	G18SG	E796-1796	PR38E	E922-1922
CS350A	E923-1923	DV16	E798-1798	G18SH	E796-1796	PS15A	E796-1796
CS35B	E923-1923	DV18	E798-1798	G18U	E796-1796	PSM7	E923-1923
D10	E798-1798	DV20	E798-1798	G18UA	E796-1796	PSM8	E796-1796
D10YA	E921-1921	DW15	E798-1798	G18UB	E796-1796	PSM9	E796-1796
D12	E798-1798	F1000A	E796-1796	G23MR	E1699	PSU13	E796-1796
D13/SA	E922-1922	F20A	E921-1921	G23SA/SB	E923-1923	PSU14	E796-1796
D13T/V/VB	E798-1798	F30A	E922-1922	G23SC	E796-1796	PSU6	E922-1922
D13Y	E922-1922	F30AT	E922-1922	G23SD//SE/SF	E796-1796	PSU7	E796-1796
D6	E798-1798	F445	E798-1798	G23SC2	E796-1796	PSU8	E796-1796
DC120V	E922-1922	F8	E922-1922	G23SC3	E1699	PSU9	E796-1796
DG6	E798-1798	FC5	E798-1798	G23SF2-UB2	E1699	PUPM3	E922-1922
DH16V	E798-1798	FC6	E922-1922	G23U/UA/UB	E796-1796	S0110	E921-1921
DH18V6	E798-1798	FC7	E922-1922	GP13	E923-1923	S0D110	E921-1921
DH20PB	E798-1798	FCH66	E798-1798	GP2	E921-1921	S15	E922-1922
DH20V	E921-1921	FCJ55	E798-1798	GS23	E796-1796	SAH180	E923-1923
DH22V	E921-1921	FCJ55V	E796-1796	GS231	E796-1796	SAT180	E922-1922
DH22VA	E921-1921	FCJ65V	E798-1798	GS232	E796-1796	SAT182	E922-1922
DH22VB	E798-1798	FCJSS	E798-1798	H41	E922-1922	SAY150A	E921-1921
DH22VD	E798-1798	FCJSS65V	E798-1798	H45SA	E922-1922	SB10	E922-1922
DH24DV	E1799.06	FCJSSV-VA	E798-1798	H50	E922-1922	SB110	E923-1923
DH24DVA	E1799.06	FD10	E798-1798	H55	E923-1923	SB75	E922-1922
DH24PA-PB	E798-1798	FDT16V	E798-1798	H60	E796-1796	SB8	E922-1922
DH24PB2	E930-1930	FDT20JA	E798-1798	H65	E796-1796	SP13	E921-1921
DH24PC-PC3	E798-1798	FDTVA	E798-1798	H70	E796-1796	SP18	E922-1922
DH24PC2	E930-1930	FDV12T	E798-1798	H85	E796-1796	SR15	E923-1923
DH24PD-PE	E798-1798	FDV15	E798-1798	H90	E796-1796	SV12	E798-1798
DH24VB-VD	E798-1798	FDV16	E798-1798	HU12	E923-1923	SV12	E921-1921
DH25DAL	E1799.06	FDV20	E798-1798	HU14	E923-1923	SV12	E798-1798
DH25DL	E1799.06	FG10SA	E921-1921	LDU4	E921-1921	SV12S	E798-1798
DH25V	E921-1921	FG12	E921-1921	LUH7	E798-1798	SV12V	E798-1798
DH28Y	E922-1922	FG12A2	E921-1921	M12	E796-1796	SV13	E798-1798
DH30	E922-1922	FH35SA	E798-1798	M6SA	E921-1921	SV8SA	E798-1798
DH38	E922-1922	FH45	E798-1798	M6SB	E921-1921	TR12	E923-1923
DH38DAL	E1799.06	FJ50	E798-1798	M8	E922-1922	TR6	E921-1921
DH38DL	E1799.06	FM8	E798-1798	NUDH4	E798-1798	TR8	E922-1922
DH40	E922-1922	FP10SA	E798-1798	NUPSR3	E922-1922	VR16	E921-1921
DH42	E922-1922	FP20SA	E798-1798	NUSR	E922-1922	VR38	E922-1922



Máquina	Refer.
VRV16	E921-1921
VTP10	E798-1798
VTP13	E798-1798
VTP16	E922-1922
VTV16	E922-1922
W4	E921-1921
W6	E798-1798
WH12	E921-1921
WH14	E921-1921
WH16	E921-1921
WH22	E921-1921
YC14	E796-1796
YC2	E796-1796

### KANGO

400	E414
422	E449
426	E449
430C	E453
500-501	E414
522-526	E453
627-628	E415
637-638	E416
800	E417-1417
900-900X	E417-1417
900-900KS	E1456
900KV-MV	E448
900-900X	E1455
950-950X	E1455
950-950X	E417-1417
950KV	E448
2500	E450
1400-1*	E451
1400-2*	E452

### KRESS

1050PKC	E599
1050SKC	E599
1052WSE	E599
1150PSK	E1594
1400KS	E782-1782
1600KS	E782-1782
200RS	E784
2400WSE	E788-1788
240APBE	E598
240PAH	E595
250RSE	E784
280DSXL	E599
380BM	E786-1786
420BME	E592
420BS	E593
420SM	E784
450BS	E593
450ES	E786-1786
450SM	E784

Máquina	Refer.
450TBS	E593
455TBS	E593
520BM	E786-1786
520P	E783
600PSE	E599
600SM	E786-1786
600WS	E783
650PS	E783
720FH	E784
750	E599
800BS	E599
800SM	E786-1786
800WS	E783
802WS	E599
900	E599
APH240	E595
CBS680	E784
CDS6420	E599
CDS6422	E599
CDS6424	E599
CHKS6050	E781
CHKS6055	E781
CHKS6060-66	E782-1782
CPS6125-1	E784
CRS6165	E784
CRS6170	E784
CRS6175	E784
CST6170	E784
CST6230	E599
CST6235	E599
CST6240	E783
CST6242	E599
CST6268	E784
EH6701	E786-1786
EHS121	E780
EST6286	E786-1786
FM6956	E599
FM6990	E599
HM102	E786-1786
HM242	E786-1786
HME18	E599
HME20	E599
HMX24	E599
NTS1100	E596
OF6901	E786-1786
OF6990	E599
PH500	E599
PSE500	E599
PSX550	E599
PSX600	E599
SB2210	E784
SBLR2250	E599
SBLR2255	E599
SBLR2360	E599
SBLR2362	E599

Máquina	Refer.
SBLR2475	E599
SBLR2480	E599
SBLR4213	E786-1786
SBLR8614	E786-1786
WS6350	E783
WS6368	E599
WS6372	E1119
WS6375	E599
WS6380	E599
WS6382	E1119
WS6390	E599
WS6701	E786-1786
WSE2200	E788-1788
WTS6350R	E785-1785
WTS6360	E788-1788
WTS6361	E788-1788
WTS6380	E788-1788
WTS6381	E788-1788

### LEGNA

C173	E702
FU3-4	E731
G82	E703
L0182	E704
L0683	E702
L0794	E702
OBS69	E702
R52	E700
R800	E703
R81	E703
SC681	E700
SR250	E702
U170	E700
V690	E700

### MAKITA

CB50	E857
CB51	E857
CB52	E832
CB55	E834
CB56	E851
CB57	E851
CB60	E1878
CB63	E833
CB64	E851
CB65	E853
CB70	E850
CB72	E853
CB100	E840-1840
CB101	E840-1840
CB102	E840-1840
CB103	E840-1840
CB105	E840-1840
CB106	E855-1855
CB113	E855-1855

Máquina	Refer.
CB117	E855-1855
CB119	E862
CB152	E848-1848
CB153	E848-1848
CB154	E848-1848
CB155	E848-1848
CB161	E848-1848
CB166	E855-1855
CB171	E1899.07
CB203	E914-1914
CB204	E914-1914
CB251	E849
CB253	E899.14
CB302	E1831
CB303	E1875
CB304	E1875
CB318	E1652
CB403	E858
CB408	E856
CB411	E856
CB414	E839
CB415	E1860
CB417	E1860
CB419	E861
CB424	E653
CB429	E654
CB430	E655
CB431	E656
CB432	E654
CB434	E656
CB600	E1878
500	E856-1856
600LR	E851
800	E861
906	E851-1835
910	E861
1001	E840-1840
1100	E840-1840
1125	E855-1855
1600	E840-1840
1804	E848-1848
1805	E848-1848
1806	E848-1848
1900	E857-1857
1901	E857-1857
1902	E857-1857
1911	E855-1855
1923	E857-1857
1923H	E857-1857
2012	E848-1848
2030	E848-1848
2040	E848-1848
2106	E840-1840
2106W	E840-1840
2400	E848-1848



Máquina	Refer.	Máquina	Refer.	Máquina	Refer.	Máquina	Refer.
2412	E848-1848	5014B/NB	E848-1848	6905V	E853-1852	9514	E850-1850
2414B	E914-1914	5016	E858	6906	E840-1840	9520	E856-1856
2414K	E848-1848	5016B/NB	E848-1848	6950	E856-1856	9521	E856-1856
2416	E848-1848	5077	E848-1848	7104	E848-1848	9522	E856-1856
2708	E848-1848	5100	E848-1848	7305	E848-1848	9524	E856-1856
2711	E848-1848	5100	E848-1848	8035	E840-1840	9525	E856-1856
3600	E848-1848	5103	E848-1848	8406	E855-1855	9527	E856-1856
3601	E848-1848	5103	E914-1914	8410	E851	9528	E856-1856
3604	E848-1848	5103	E914-1914	8419B	E857-1857	9541	E1831
3606	E855-1855	5143	E914-1914	8419B2	E834	9542	E1831
3608	E855-1855	5143	E914-1914	8419SB	E834	9553-54-55	E661
3612	E914-1914	5201	E848-1848	8420	E855-1855	9556-57-58	E661
3612BR	E848-1848	5401	E848-1848	8900	E848-1848	9595	E853-1852
3612C	E914-1914	5402	E848-1848	9005	E840-1840	9607	E848-1848
3620	E855-1855	5500	E848-1848	9006	E840-1840	9609	E848-1848
3700	E857-1857	5600BR	E848-1848	9015	E1875	9629	E914-1914
3702	E857-1857	5600NB	E840-1840	9016	E1875	9741	E840-1840
3703	E856-1856	5800BR	E848-1848	9027	E914-1914	9900	E840-1840
3704	E856-1856	5800NB	E840-1840	9027F	E914-1914	9901	E840-1840
3705	E853-1852	5603	E1875	9027S	E914-1914	9910	E856-1856
3706	E851	5700	E848-1848	9029	E914-1914	9911	E856-1856
3707-3708	E856-1856	5703	E1875	9029F	E914-1914	9924	E840-1840
3800	E848-1848	5800	E848-1848	9029SF	E914-1914	B04510	E851-1835
3901	E856-1856	5900	E848-1848	9030	E857-1857	B04540	E851
4014B	E857-1857	5900	E848-1848	9031	E856-1856	B04550	E851
4014M	E857-1857	5903	E914-1914	9035	E851	B04553	E851
4014N	E857-1857	6000	E851-1835	9035KB	E853-1852	B04554	E851
4014NV	E840-1840	6010B	E851	9035-N	E851-1835	B04560	E851
4100NB	E840-1840	6010VA	E851-1835	9035SB	E851	B04561	E851
4100R	E840-1840	6010VBR	E851	9036	E850-1850	B04563	E851
4101	E849	6013	E857-1857	9037	E914-1914	B05000	E861
4105	E840-1840	6016	E857-1857	9037F-SF	E914-1914	B05001	E861
4107	E848-1848	6300	E857-1857	9039-F-S-SF	E914-1914	B05010	E851
4110	E848-1848	6300T	E834	9039	E914-1914	B06010	E853-1852
4114N	E840-1840	6310	E861	9041	E848-1848	B06020	E853-1852
4204N	E853-1852	6402	E1860	9045	E840-1840	DA3000	E853-1852
4300BA/BV	E857-1857	6408	E861	9046	E861	DA4511	E840-1840
4300SB	E851	6410	E861	9047	E914-1914	DP4700	E851
4301BV	E857-1857	6501	E850-1850	9049	E914-1914	GA5000	E840-1840
4301S	E851	6510PBL	E851-1835	9059	E914-1914	GA5021C	E899.14
4301SB	E851-1835	6510SB	E851	9069	E914-1914	GA6021C	E9899.14
4301SV	E851	6700	E851	9207	E840-1840	GA7000	E848-1848
4302	E855-1855	6701	E834	9217	E840-1840	GA9000	E848-1848
4304	E861	6800	E851	9218	E840-1840	GC5000	E848-1848
4305	E861	6801B	E834	9218	E840-1840	GV5000	E851
4320	E850-1850	6801DB/DBV	E851	9227	E1875	GV6000	E851-1835
4401	E857-1857	6802	E851	9297	E840-1840	GV6000R	E851
4402	E856-1856	6805	E851	9400	E848-1848	HK1800	E840-1840
4603	E839	6820	E1860	9401	E848-1848	HK1810	E840-1840
5000SBR	E853-1852	6821	E861	9402	E848-1848	HM0810	E840-1840
5007	E848-1848	6830	E856-1856	9501BM	E856-1856	HM0821	E840-1840
5008	E848-1848	6832	E856-1856	9501CB	E853-1852	HM1100	E1875
5011	E848-1848	6904	E1860	9503	E853-1852	HM1130	E1875
5012	E848-1848	6905B	E853-1852	9505BH	E853-1852	HM1200	E848-1848
5014	E858	6905H	E1860	9505BM	E856-1856	HM1201	E848-1848



Máquina	Refer.	Máquina	Refer.	Máquina	Refer.	Máquina	Refer.
HM1300	E848-1848	JR3000V	E834	2636	E808-1808	BA0655	E802-1802
HM1301	E848-1848	JR3010	E855-1855	2E680/2S	E801/1801	BA0666	E802-1802
HM1303	E914-1914	JR3020	E849	3360	E804-1804	BA0775	E804-1804
HM1400	E848-1848	JR3608	E855-1855	4308	E801-1801	BA0876	E805-1805
HM1500	E914-1914	JS1600	E853-1852	4310	E801-1801	BA6100	E817-1817
HM1800	E914-1914	JS1650	E853-1852	4315	E809-1809	BAD665	E801-1801
HP1300	E851	JS1660	E853-1852	4316	E809-1809	BAE0666	E801-1801
HP1500	E861	JS1670	E853-1852	4330	E802-1802	BAE0875	E804-1804
HP2000	E855-1855	JS3200	E840-1840	4345	E805-1805	BE350	E815-1815
HP2010	E855-1855	JV2000	E840-1840	4346	E805-1805	BE460	E815-1815
HP2020	E855-1855	LS0810	E840-1840	6127	E808-1808	BE500	E800-1800
HP2030	E861	LS1011	E848-1848	6129	E808-1808	BE504	E814-1814
HP2031	E861	LS1013	E848-1848	6139	E809-1809	BE620	E800-1800
HP2040	E861	LS1020	E848-1848	6140	E809-1809	BE720	E813-1813
HP2041	E861	LS1030	E848-1848	6155	E809-1809	BH1130	E807-1807
HP2042	E861	LS1400	E848-1848	6158	E809-1809	BH1131	E807-1807
HP2404	E855-1855	LS1440	E848-1848	6160	E809-1809	BHE1129	E805-1805
HR1800	E840-1840	LS1500	E848-1848	6161	E809-1809	BHE6020	E801-1801
HR1820	E840-1840	LS1510	E848-1848	6162	E804-1804	BHE6026	E801-1801
HR2000	E855-1855	MM32/2	E857-1857	6171	E809-1809	BHE6030	E805-1805
HR2010	E840-1840	N1923B	E857-1857	6305	E809-1809	CB502	E814-1814
HR2010N	E855-1855	N4105KB	E840-1840	6310	E809-1809	E1120	E801-1801
HR2020	E861	N4304	E861	6323	E805-1805	E450	E802-1802
HR2220	E840-1840	N4305	E861	6341	E801-1801	E452	E815-1815
HR2400	E1860	N500	E856-1856	6342	E801-1801	E620	E800-1800
HR2410	E861	N6510	E851	6343	E800-1800	EDU800	E801-1801
HR2431-40-50	E861	N800	E861	6344	E800-1800	EK600	E800-1800
HR2510	E840-1840	N910	E861	6346	E800-1800	EP563	E809-1809
HR2D10	E855-1855	N9500	E856-1856	6870	E809-1809	EP564	E809-1809
HR3000	E1875	N9501	E856-1856	6872	E809-1809	EP566	E810-1810
HR3500	E840-1840	N9503	E856-1856	61065	E808-1808	EW10.125	E804-1804
HR3510	E840-1840	NCP1100	E840-1840	61068	E808-1808	EW115S	E810-1810
HR3520	E840-1840	NHP1300	E1860	61167	E808-1808	EW117	E819-1819
HR3600	E848-1848	PC1100	E840-1840	61169	E808-1808	EW125S	E810-1810
HR3850	E848-1848	SR1001	E840-1840	61265	E808-1808	EW4316	E809-1809
HR4000	E1875	SR1600	E840-1840	61268	E808-1808	EW6114	E819-1819
HR4001C	E1662	SR1800	E840-1840	610650	E808-1808	EW6114S	E810-1810
HR4010C	E1662	SR2100	E848-1848	610680	E808-1808	EW6115S	E810-1810
HR4011C	E1662	SR2300	E848-1848	611670	E808-1808	EW6124S	E810-1810
HR4500	E848-1848	SR2600	E848-1848	611690	E808-1808	EW6125S	E810-1810
HR4501C	E1899.07	UH3000	E850-1850	611760	E808-1808	EW7115	E819-1819
HR4511C	E1899.07	UH4500	E834	612650	E808-1808	EW7116	E800-1800
HR5000	E848-1848	UH4510	E862	612680	E808-1808	EW7116 V	E819-1819
HR5201C	E1899.07	UH6300	E834	750010	E801-1801	EW7117-067	E800-1800
HR5211C	E1899.07	UH6310	E862	ASR1263	E805-1805	EW7117-113	E819-1819
HR6000	E848-1848			B350	E815-1815	EW7125	E804-1804
HR6001-11C	E1662	<b>METABO</b>		B380	E815-1815	EW7126	E819-1819
HR8001-11C	E1662	450	E802-1802	B480	E814-1814	EW7126S	E800-1800
JG1600	E853-1852	451/2	E815/1815	B481	E814-1814	EW7127-067	E800-1800
JG1600	E832	455	E802-1802	B500	E814-1814	EW7127-113	E819-1819
JG2000	E853-1852	561	E809-1809	B504	E814-1814	EW8125S	E804-1804
JN1600	E853-1852	1130B	E807/1807	B620	E800-1800	EW8125S	E813-1813
JN1601	E856-1856	1131	E807/1807	B720	E813-1813	EW9125	E819-1819
JN3200	E840-1840	1468	E805-1805	B7532	E801-1801	EW9150	E804-1804
JR3000	E857-1857	1806	E811-1811	B800	E813-1813	EW11125	E804-1804



Máquina	Refer.
EWE1115	E807-1807
EWE11150	E804-1804
EWE6115S	E810-1810
EWE7116	E819-1819
EWE9123	E819-1819
EWE9125	E819-1819
EWE9126	E819-1819
EWE9127	E819-1819
EWE9150	E804-1804
F0520	E810-1810
FM529	E810-1810
GS6139-40-45	E810-1810
H20	E814-1814
HO0882	E818-1818
HO4382	E804-1804
HS8040	E815-1815
HS8044	E815-1815
HS8055	E815-1815
HS8065	E815-1815
KN6875	E809-1809
KS0852	E801-1801
KS1155	E805-1805
KS1165	E805-1805
KS1785	E806-1806
KS4345	E805-1805
KS4345	E805-1805
KS4346	E806-1806
KS65	E805-1805
KSE16685	E805-1805
KSE1678	E805-1805
KSE1785	E805-1805
KU6870	E809-1809
KU6872	E809-1809
KU6873	E810-1810
P14175	E806-1806
P6155	E809-1809
P6155	E810-1810
PB501	E809-1809
PSE0525	E810-1810
PSE102	E816-1816
RWE1100	E1899.03
SB13	E779
SB450	E802-1802
SB460	E802-1802
SB505	E809-1809
SB600	E800-1800
SB620	E800-1800
SB650	E1821
SB650-2RL	E800-1800
SB651	E800-1800
SB720	E813-1813
SB800	E800-1800
SBE110	E801-1801
SBE380	E814-1814
SBE420	E814-1814

Máquina	Refer.
SBE450	E802-1802
SBE460	E802-1802
SBE480	E800-1800
SBE500	E809-1809
SBE560	E829
SBE570	E800-1800
SBE600	E800-1800
SBE620	E800-1800
SBE650	E800-1800
SBE651	E800-1800
SBE680	E800-1800
SBE700	E800-1800
SBE701	E800-1800
SBE710	E800-1800
SBEDU100	E801-1801
SBEDV1000	E800-1800
SBEDV1015	E800-1800
SBEDV800	E813-1813
SBEK600	E800-1800
SBEK680	E800-1800
SBEK750	E801-1801
SBEK750-2S	E800-1800
SE350	E815/1815
SE4410	E815-1815
SE4420	E814-1814
SE4430	E814-1814
SE4431	E814-1814
SE4450	E814-1814
SE6341	E800-1800
SE6342	E800-1800
SE6343	E800-1800
SE6344	E800-1800
SE6345	E800-1800
SE6346	E800-1800
SN14125	E806-1806
SR10-23	E899-01
SR castor	E899-01
SR220	E802-1802
SR221	E815-1815
SR225	E802-1802
SR226	E815-1815
SR227	E815-1815
SR282	E802-1802
SR283	E802-1802
SR284	E802-1802
SR285	E802-1802
SR326-328	E802-1802
SR3320	E802-1802
SR4320	E802-1802
SR4321	E802-1802
SRE217	E815/1815
SRE285	E802-1802
SRE327-329	E815/1815
ST350	E815-1815
ST450	E815-1815

Máquina	Refer.
STE350	E815-1815
STE450	E815-1815
STEP564	E810-1810
STEP565	E810-1810
TK548	E810-1810
TR2636	E808-1808
TR3300	E806-1806
W 10 125	E1824
W 115	E1824
W 14-125 ergo	E1899.03
W 14-150 ergo	E1899.03
W 14 175	E806-1806
W 14 176	E805-1805
W 16 167	E806-1806
W 16 178	E806-1806
W 16 230	E806-1806
W 19 178	E806-1806
W1923	E806-1806
W 19 230	E806-1806
W1980	E806-1806
W2018	E805-1805
W 20 180	E806-1806
W 20 180 1	E805-1805
W20 180X-071	E805-1805
W20 180X-084	E806-1806
W20187	E806-1806
W 20 230	E1822
W20 230-071	E805-1805
W20 230-084	E806-1806
W20237	E806-1806
W2030	E1825
W2031x	E1825
W2080	E806-1806
W2080	E1825
W2081x	E1825
W 21 180	E806-1806
W 21 230	E806-1806
W21239	E806-1806
W2230	E1825
W2232x	E1825
W2280	E1825
W2281x	E1825
W2282x	E1825
W 23 180	E806-1806
W 23 230	E806-1806
W 25 180	E806-1806
W25230	E806-1806
W7-115	E1824
W8-115	E1899.13
W8-115 QUICK	E1899.13
WBE500	E809-1809
WE 14-125 ergo	E1899.03
WE 14-150 ergo	E1899.03
WE24180	E806-1806
WE24230	E806-1806

Máquina	Refer.
WS20230	E1822
WS2030	E1822
WS2080	E1822
WS2530	E1822
WS3315	E809-1809
WS3316	E809-1809
WS515	E810-1810

### PERLES

F35F	E907
Frecuencia	E708
HB1520	E901
HB160	E901
HB165	E901
HB260	E901
HB265	E901
HSE716	E907
HSW109	E903
HSW1111	E777
HSW115	E917
HSW15	E777
HSW222	E904
HSW225	E904
HSW325	E917
HSW356	E905
HSW358	E905
HSW56	E906
HSW596	E906
HSW598	E906
HSW716	E907
HSW728	E907
PSB137	E910
PSB270	E902
PSB2700	E902
PSB272	E902
PSB275	E902
PSSB1530	E901
UP702	E907
UP702W	E907
UP704	E907
WSE728	E907
XB110	E900
XB210	E900

### PROTOOL

AGP115	E1571
AGP115	E1572
AGP125	E1571
AGP125	E1572
AGP150	E1571
AGP150	E1578
AGP180	E1570
AGP230	E1570
AGP230	E1574
BSP85	E1572



Máquina	Refer.
CHP2	E580
CHP5	E1573
CSP55	E1573
DGP25	E1572
DGP30	E1572
DRP8-10-13	E1575
DRP16-20	E1573
IWP30	E1573
JSP85	E1572
MXP160	E1573
MXP1000	E1573
PDP13-16-18	E1575
PDP20-24	E1575
PDP30-32	E1573
RGP3	E1572
SGP25	E1572
SGP30	E1572
SHP16	E1572
SHP25	E1572
SHP35	E1573
VPB20	E1572

#### RUPES

133	E713
AR30	E710
AR9	E710
BA15	E742
BA215	E617
BR3	E742
BR5	E742
BR51A	E617
BR55	E617
BR8	E710
BR9	E710
CA6	E710
CE6	E710
CN6	E620
CS8	E620
CV8	E620
GM62	E625
LAR12	E619-1619
LAR2	E619-1619
LAR23	E619-1619
LAR3	E619-1619
LAR5	E619-1619
LAR8	E619-1619
LB31E	E620
LC7	E620
LDR23	E619-1619
LDR6	E619-1619
LE7	E620
LH16	E617
LH31	E639-1639
LT2	E619-1619
ND13	E712

Máquina	Refer.
ND16	E712
NL13	E739
NL2	E619-1619
NL23	E619-1619
NL3	E619-1619
PC13	E713
PC14-16E	E620
PC15	E620
PC30	E713
PD10	E739
PD13	E739
PD30	E739
PL30	E739
PN30	E712
RE72	E710
RE74	E710
RIK	E735
S130	E705
S80	E621
SM1	E619-1619
SM10	E735
SM14	E735
SM43	E639-1639
SS20	E710
SS70	E712
SSPF	E712
TN10	E620
TN13	E620
TN20	E620
TN6	E620
TN8	E620
TP13	E713
TP16	E713
TR10	E739
TR13	E739

#### RYOBI

B422	E714
B7100	E714
BE422	E714
BE424	E714
C100A	E706
C100AI	E779
C307NA	E716
C3560	E716
C356NA	E716
C357	E716
CH450PK	E761-1761
CH460PK	E761-1761
CH465	E761-1761
CH481	E716
CH485K	E761-1761
CS360	E716
D100VR	E765
D101SA	E765

Máquina	Refer.
D130VR	E765
E3900A	E765
E4000A	E765
ED205VRK	E864
ED350	E761-1761
ED381	E716
ED382ND	E716
G181	E648
G1001A	E755
G1005	E755
G1150	E741
G1151A	E755
G1155A	E755
G1250	E779
G1251A	E755
G1255	E761-1761
G1500	E706
G1800	E715-1715
G1830	E874
G1850	E715-1715
G1855	E715-1715
G1855	E756
G231	E648
G2325	E756
G2350	E715-1715
G2355	E756
G600	E755
HC310	E866
HC360	E866
HC410	E866
HC536	E866
L120N	E741
L1323A	E868
L22LN	E714
L282	E868
L580	E715-1715
NS6200A	E714
NS6300A	E714
PC3050N	E715-1715
PD1410AVR	E765
PD191VRK	E765
PD1921	E741
PD1921V	E741
PD192VR	E765
PD1956K	E765
PD1960VR	E765
RA200N	E716
RA2500N	E716
RE155-R155	E779
S500	E869
S550	E870
SG1150	E741
SG1155	E651
SG2320	E796-1796
SP180A	E779

Máquina	Refer.
SU6200A	E714
TR30	E741
TSC306	E716
W5502	E714
W55P	E741
W6402NC	E716
W8402NC	E716

#### SKIL

555H	E773
736H	E732
1400H1	E512
1489H	E987
1745	E514
1750	E514
1886H1	E516
1899H1	E773
63905	E740
6470H1	E517
666H1	E1511
6906	E872
9021AB	E1510
9021A	E1510
9021PA	E1510
9114H1	E517
9115	E768
9115H1	E517
9115H2	E517
9116H1	E517
9116H2	E517
9125H1	E517
9125H2	E517
9126H1	E517
9126H2	E517
9200B2	E1510
9200H1	E1510
9210	E1510
9270A1	E1510
9275H1	E1510
9280A1	E1510
9280H1	E1510
9295A1	E1510
9415	E1510
94H1	E513
9500-00	E1510
9645H1	E515
9650H1	E515
9660H1	E515
9665	E515
9750H1	E515
9755H1	E520-1520
9760H1	E515
9770H1	E520-1520
9775H1	E520-1520



































Máquina	Refer.
<b>STAYER</b>	
208	E723
383	E762
503	E764
980	E762
982	E762
AG680	E734
B6	E749-1749
B8	E749-1749
CL1	E762
FH720	E826
L130	E762
L130P	E762
L190	E762
LA7	E764
LEV120	E762
L0M10	E764
L0M10B	E762
L0M12	E764
L0M13	E764
L0M412	E762
L0M413	E762
LRT150	E734
LU170	E749-1749
LU172	E749-1749
LU80	E763
MP301	E762
MP302	E762
P20E	E762
P230RE	E762
PR1	E764
REC3	E762
S230	E734
S55	E762
S55E	E762
SA10	E749-1749
SA100	E762
SA107	E762
SA115	E762
SA12	E749-1749
SA125-900	E764
SA125-970	E769
SA126-900	E764
SA126-970	E769
SA127-900	E764
SA127-970	E769
SA180	E749-1749
SA230	E749-1749
SA25	E749-1749
SA290	E738-1738
SA295	E738-1738
SA297	E738-1738
SA55PE	E762
SA7	E769
SA710	E734

Máquina	Refer.
SA720	E243
SA900	E659
SA901	E659
SA1201	E659
SAP1	E762
SAP2	E762
SAP3	E762
SAP55	E762
SC205	E762
SC250	E749-1749
SC251	E749-1749
SC503	E762
SCC250	E749-1749
SCC251	E749-1749
SCU75	E749-1749
SD125	E764
SD251	E764
SD25A	E764
SLC250	E749-1749
SLC251	E749-1749
T500	E734
T550	E734
T600	E734
TC3001	E762
TC4002	E762
TC5001	E762
TC7000	E762
TC9000	E762
TM10	E762
TM100	E734
TM101	E734
TM10A2V	E762
TM10A2V	E762
TM327	E762
TM328	E762
TM340	E762
TM344	E762
TM345	E762
TM346	E762
TM348	E762
TM349	E762
TM350	E734
TM355	E762
TM366	E762
TM367	E762
TM368	E762
TM369	E762
TM386	E762
TM387	E762
TM388	E762
TM390	E762
TM391	E762
TM80A	E762
TM8A	E762
TM8S	E762

Máquina	Refer.
TS50	E734
TS60	E734
W1000A	E734
W500	E762
W551	E734
W700	E762
Z10	E763
Z13	E749-1749
Z20	E749-1749
Z202-900	E762
Z202-970	E769
Z203	E762
Z207	E762
Z207A	E764
Z25	E749-1749
Z7	E749-1749
Z9	E749-1749
<b>VIRUTEX</b>	
A92	E500
AB11	E503
AB111N	E550
A197	E503
A197	E500
AK97	E503
AL96	E500
AP98	E500
AS93	E500
B65	E500
BL96	E500
C67	E500
C93N	E503
CE23N	E506
CE24H	E500
CE35E	E506
CE89C	E501
CE89E	E506
CE96H	E506
CE120P	E550
CE123N	E506
CR94D	E505
DE87C	E505
E70	E500
F71	E504
FR29C	E505
FR29K	E505
FR29M	E505
FR56E	E505
FR66F	E500
FR92D	E505
FR98H	E500
FR117N	E505
FR129	E550
FR156	E550
FR160	E507

































Máquina	Refer.
FR192N	E550
FR217S	E550
FR292R	E550
G71	E502
GR120P	E550
H71	E500
I81N	E503
J71	E501
K75	E500
LB31	E500
LR46L	E508
LR67B-D	E734
LR67L	E508
LR84H	E508
LR86C	E500
LR184N	E506
LRE46L	E508
LRE46L	E508
LRE84H	E506
LRE86C	E500
LRT84H	E506
M75	E500
MC16I	E500
O81N	E503
P75	E500
PA162	E550
PD	E508
PDE	E508
RA17D	E505
RO56D	E505
RO156N	E550
RT	E508
RT88C	E505
RT91C	E500
RT188N	E550
RTE	E508
RZ70M	E505
RZ170N	E550
TM33	E507
TM33H	E507
TM33L	E507
TM43D	E500
TM43J	E507
TM43L	E507
TS33H	E507
TS33L	E507
TS48D	E500
TS48J	E507
TS48L	E507
V79	E500
Z81N	E503

## Estuche escobillas m. electro portátiles EE-51

							
<b>Bosch E-100</b> 6,4 * 6,4 * 15,5 4	<b>Bosch E-107</b> 6,4 * 12,5 * 19 4	<b>Bosch E-109</b> 5 * 8 * 15,5 6	<b>Bosch E-112</b> 6,3 * 16 * 22,5 6	<b>Bosch E-114</b> 5 * 8 * 17,5 6	<b>Bosch E-119</b> 6,3 * 16 * 22,5 6	<b>Bosch E-123</b> 6,3 * 12,5 * 23 4	<b>Bosch E-141</b> 5 * 8 * 18 6
							
<b>Bosch E-1128</b> 6,3 * 16 * 23,5 4	<b>Bosch E-1146</b> 5 * 10 * 17 6	<b>Bosch E-1152</b> 5 * 10 * 17 6	<b>B &amp; D E-220</b> 6,3 * 12,5 * 23,5 4	<b>B &amp; D E-221</b> 6,3 * 16 * 22,5 4	<b>B &amp; D E-222</b> 6,3 * 8 * 13,5 4	<b>Aeg E-302</b> 5 * 8 * 14 4	<b>Aeg E-309</b> 5 * 8 * 15 4
							
<b>Aeg E-320</b> 6,3 * 12,5 * 20 4	<b>Aeg E-1366</b> 5 * 10 * 15 4	<b>Casals E-405</b> 5 * 8 * 15 4	<b>Casals E-1423</b> 6,3 * 16 * 22,5 4	<b>Casals E-424</b> 5 * 10 * 14,5 4	<b>Casals E-425</b> 5 * 8 * 15 4	<b>Hitachi E-796</b> 7 * 17 * 17 4	<b>Hitachi E-923</b> 7 * 13 * 17 4
							
<b>Kango E-417</b> 6,3 * 9,5 * 20 4	<b>Makita E-861</b> 6 * 9 * 11 4	<b>Makita E-1860</b> 6 * 9 * 12,5 4	<b>Makita E-1875</b> 5 * 11 * 16,5 4	<b>Metabo E-1824</b> 5 * 10 * 16 4	<b>Metabo E-1825</b> 6 * 16 * 22 4	<b>Stayer E-749</b> 6 * 14 * 22 4	<b>Virutex E-500</b> 6,4 * 10 * 19 4



## Estuche escobillas m. electro portátiles EE-52

							
<b>Hilti E-1622</b> 7 * 12,5 * 26 4	<b>Hilti E-1623</b> 6,3 * 10 * 19 4	<b>Hilti E-1772</b> 6,3 * 12,5 * 23 4	<b>Hilti E-774</b> 6,3 * 8 * 25 4	<b>Hilti E-1791</b> 6,3 * 8 * 18,5 4	<b>Hilti E-1792</b> 6,3 * 12,5 * 19 4	<b>Hilti E-1793</b> 5 * 8 * 12 4	<b>Hilti E-1794</b> 6,3 * 10 * 26 4
							
<b>Makita E-1831</b> 5 * 11 * 12 4	<b>Makita E-1840</b> 6 * 10 * 15 4	<b>Makita E-848</b> 6,5 * 13,5 * 16 4	<b>Makita E-857</b> 5 * 8 * 12 4	<b>Makita E-914</b> 7 * 18 * 16 4	<b>Metabo E-775</b> 6,3 * 8 * 19,5 4	<b>Metabo E-800</b> 6,3 * 8 * 12 4	<b>Metabo E-1801</b> 6,3 * 8 * 15 4
							
<b>Metabo E-802</b> 6 * 6 * 13 4	<b>Metabo E-804</b> 6,3 * 8 * 15 4	<b>Metabo E-1805</b> 6,3 * 12,5 * 18 4	<b>Metabo E-1806</b> 8 * 14 * 18 4	<b>Metabo E-1807</b> 6,4 * 10 * 21 4	<b>Metabo E-1808</b> 8 * 14 * 19 4	<b>Metabo E-1809</b> 6,4 * 6,4 * 14,5 4	<b>Metabo E-1810</b> 6,3 * 6,3 * 14 4
							
<b>Metabo E-1811</b> 8 * 14 * 18 4	<b>Metabo E-1813</b> 6,3 * 8 * 15 4	<b>Metabo E-1814</b> 5 * 6,4 * 15 4	<b>Metabo E-815</b> 6 * 6 * 11,5 4	<b>Metabo E-1817</b> 6,4 * 8 * 16 4	<b>Metabo E-1818</b> 6,3 * 6,3 * 16 4	<b>Metabo E-1819</b> 6,4 * 8 * 16 4	<b>Metabo E-1822</b> 6 * 16 * 20 4